



CITY

7723



WARNING: CHOKING HAZARD.
Small parts. Not for children under 3 years.

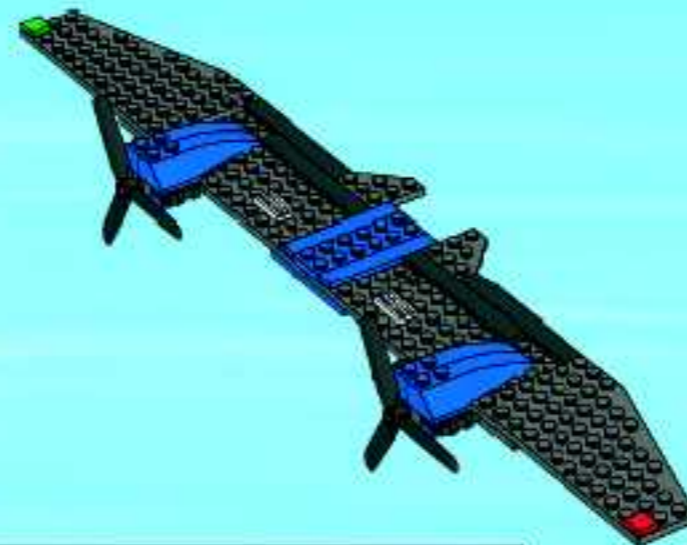
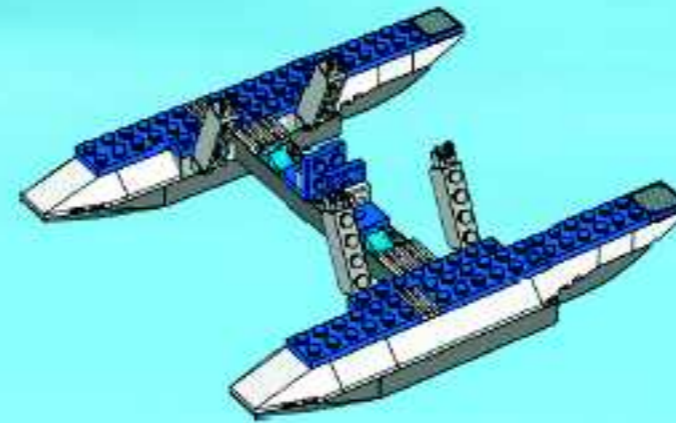
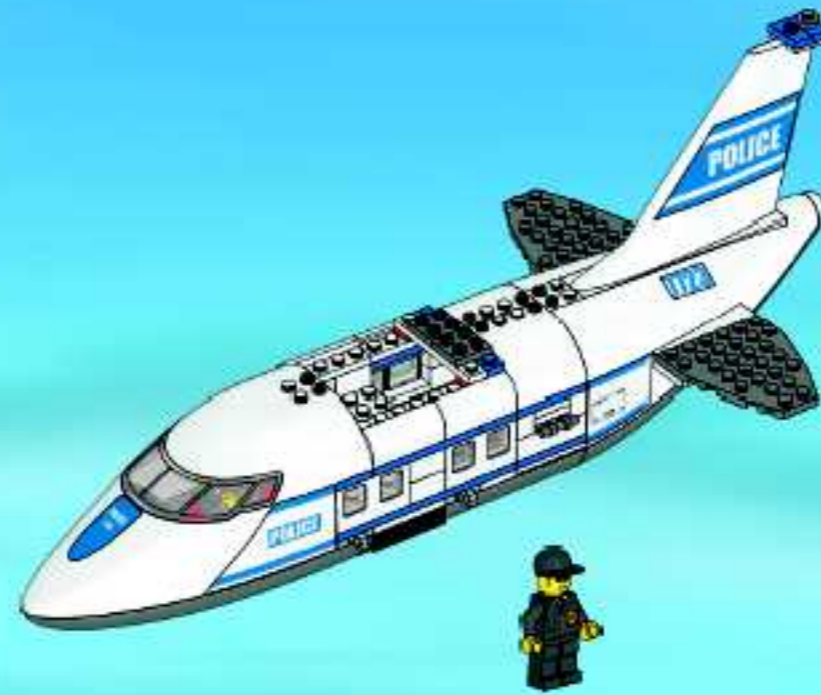

AVERTISSEMENT : RISQUE D'ÉTOUFFEMENT.
Contient des petites pièces. Ne convient pas aux enfants de moins de 3 ans.



ADVERTENCIA: PELIGRO DE ASFIXIA.
No recomendado para niños menores de 3 años. Contiene piezas pequeñas.

1

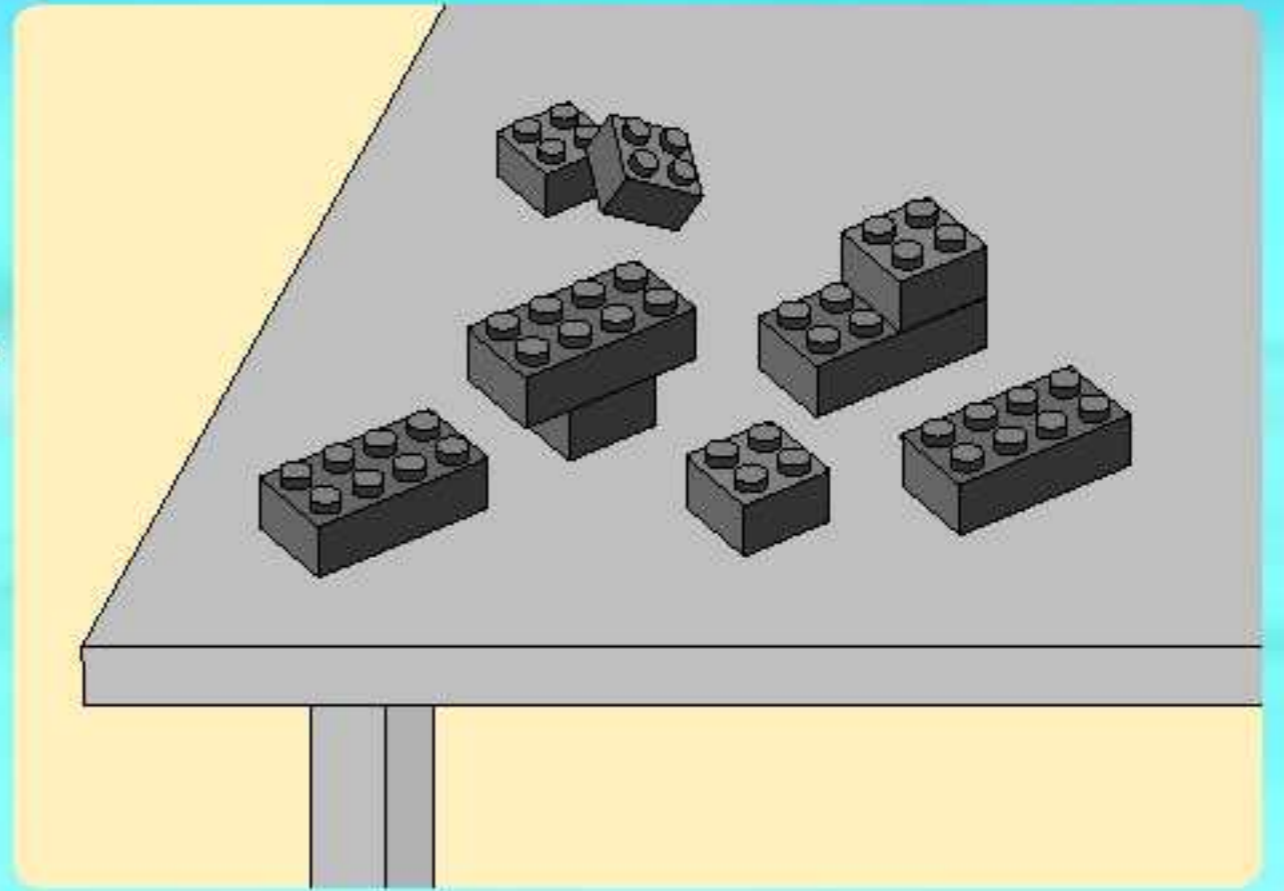
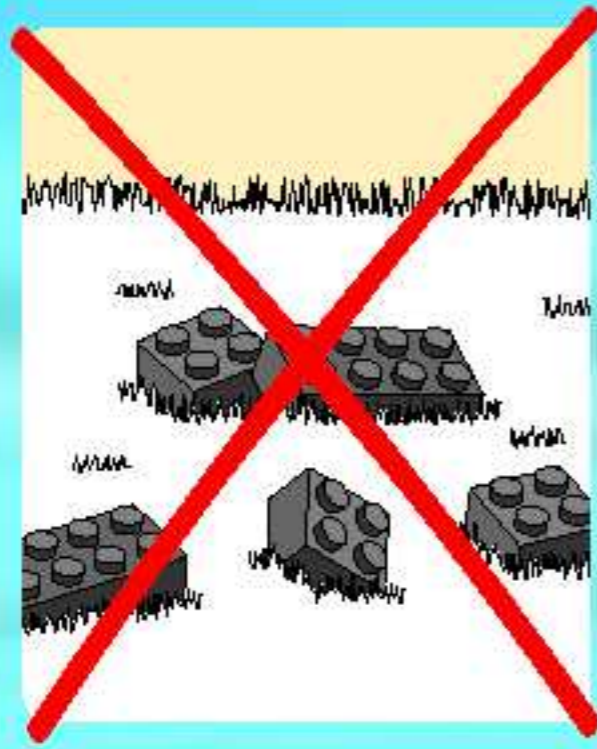

2

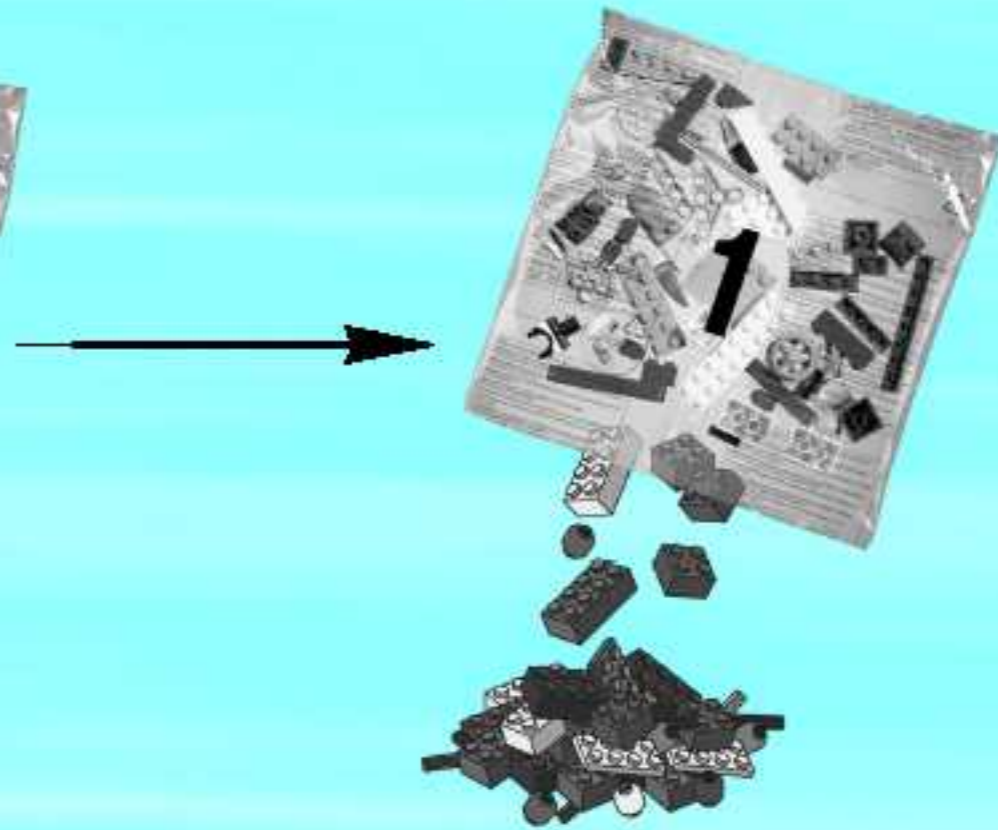



+

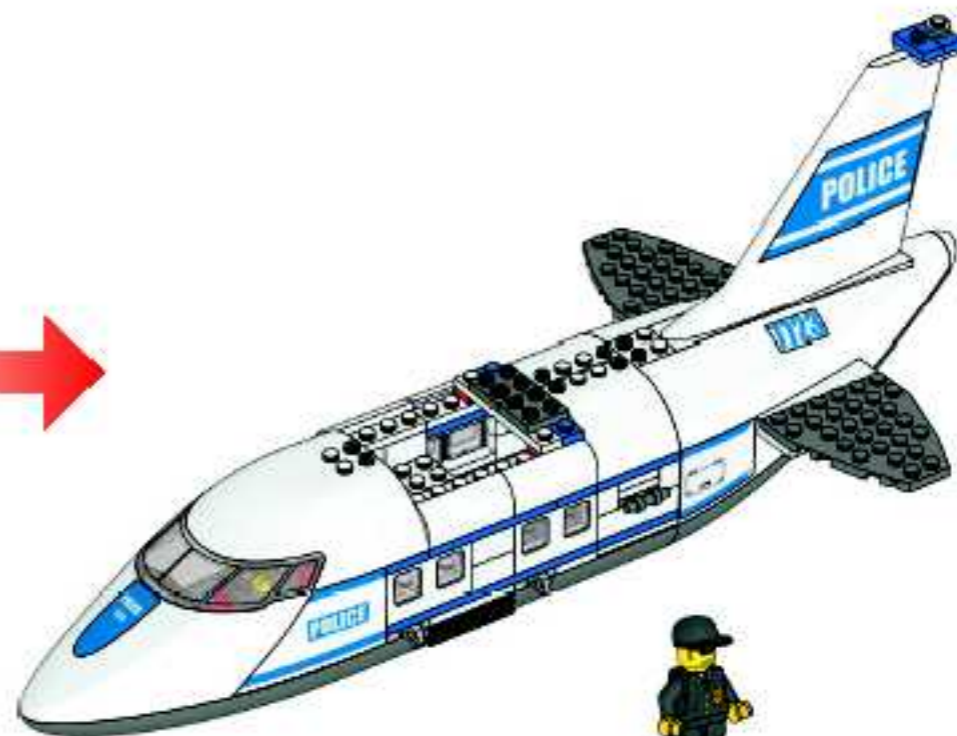

3



1

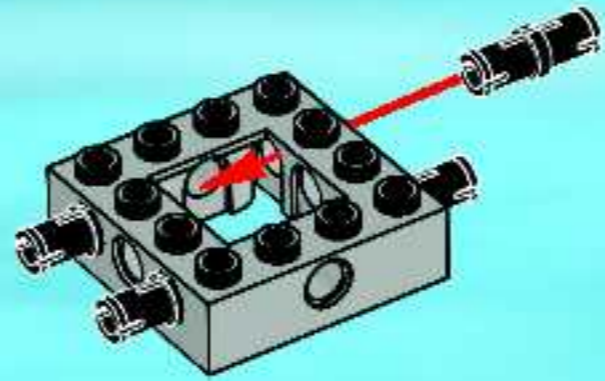

2

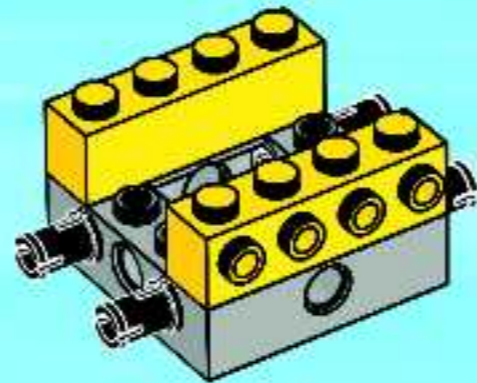

3

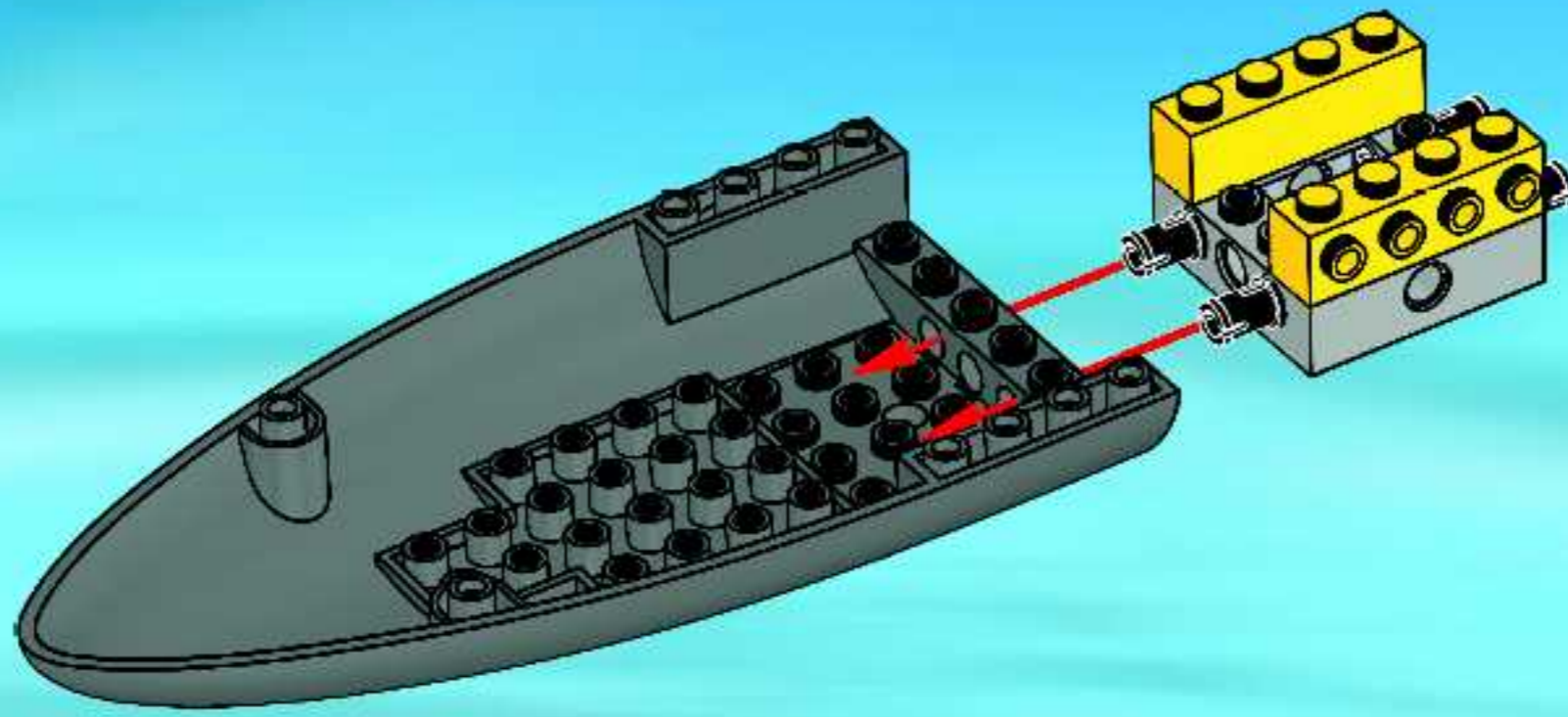

4

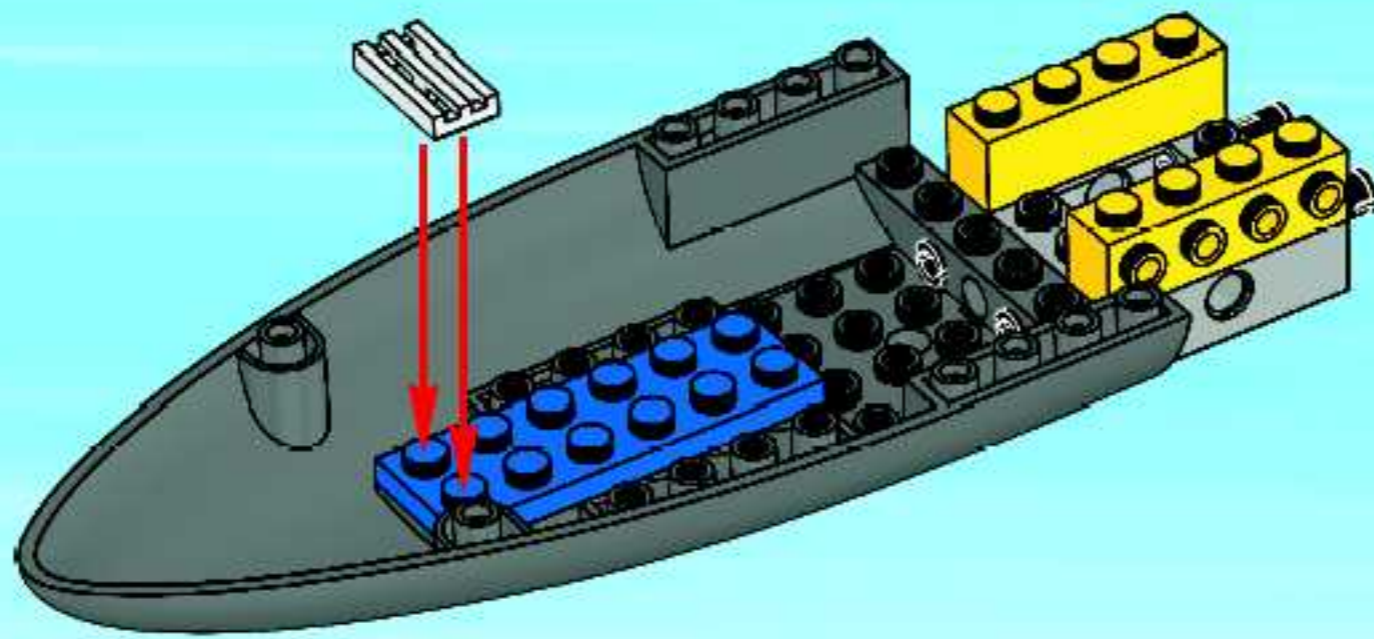

5

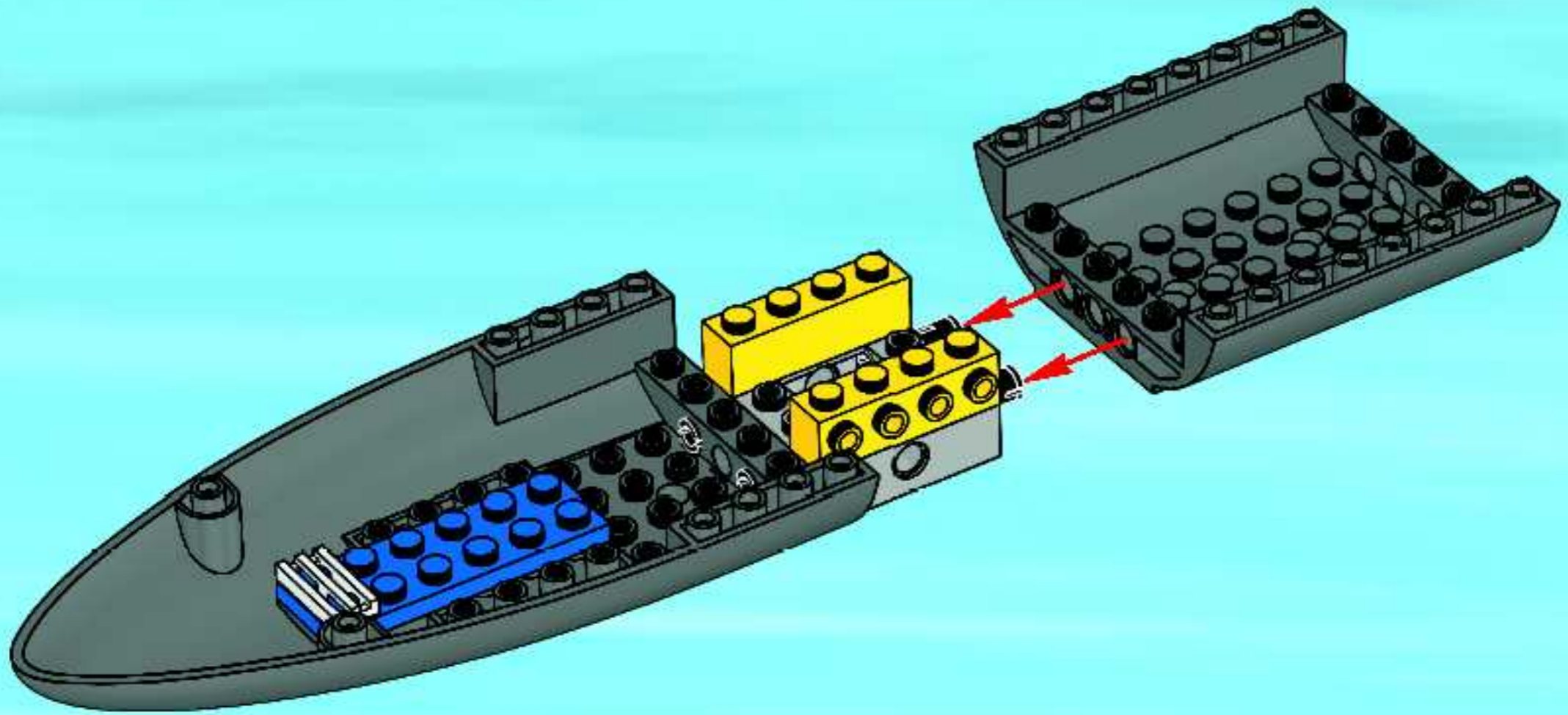

6

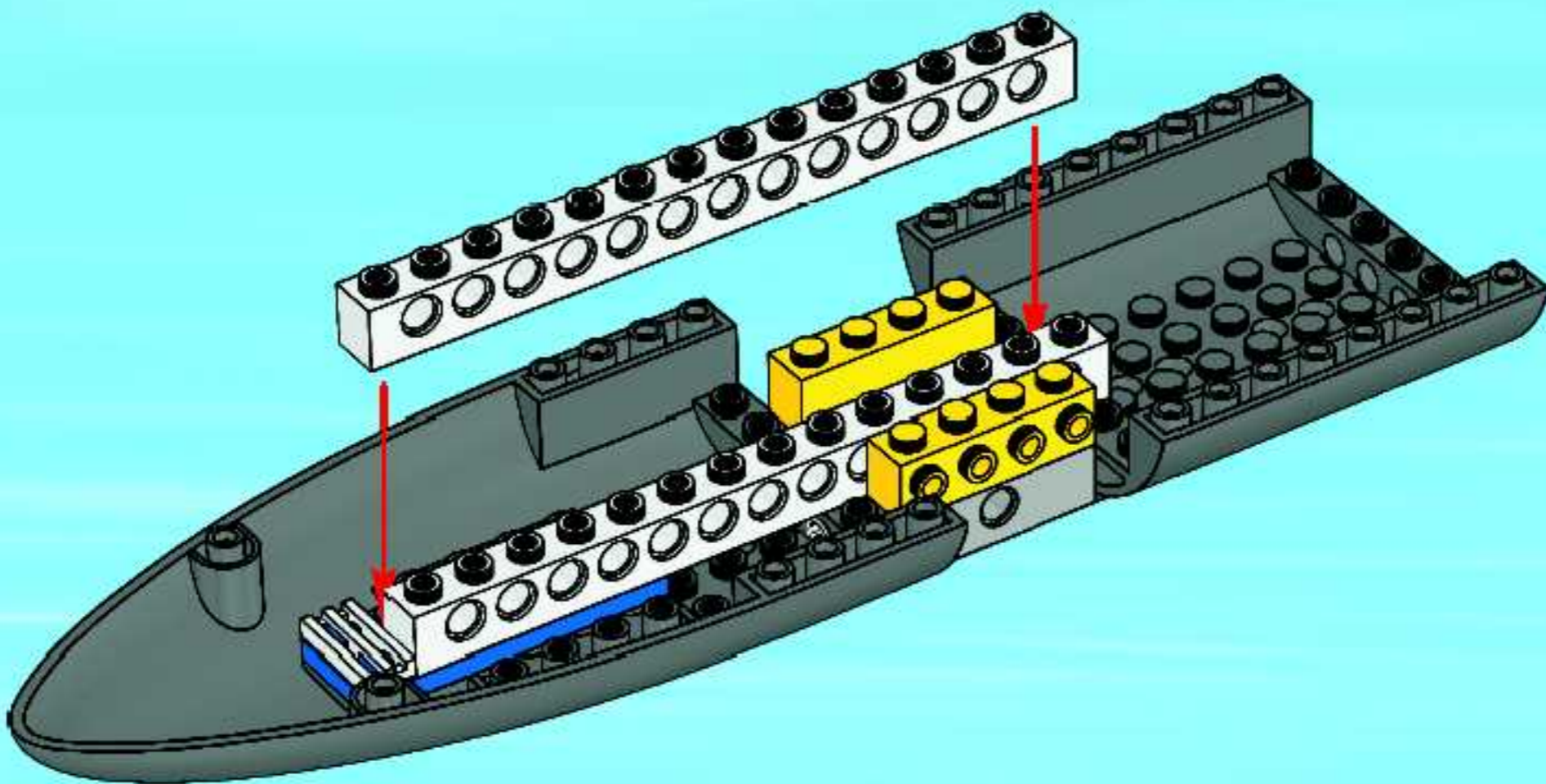

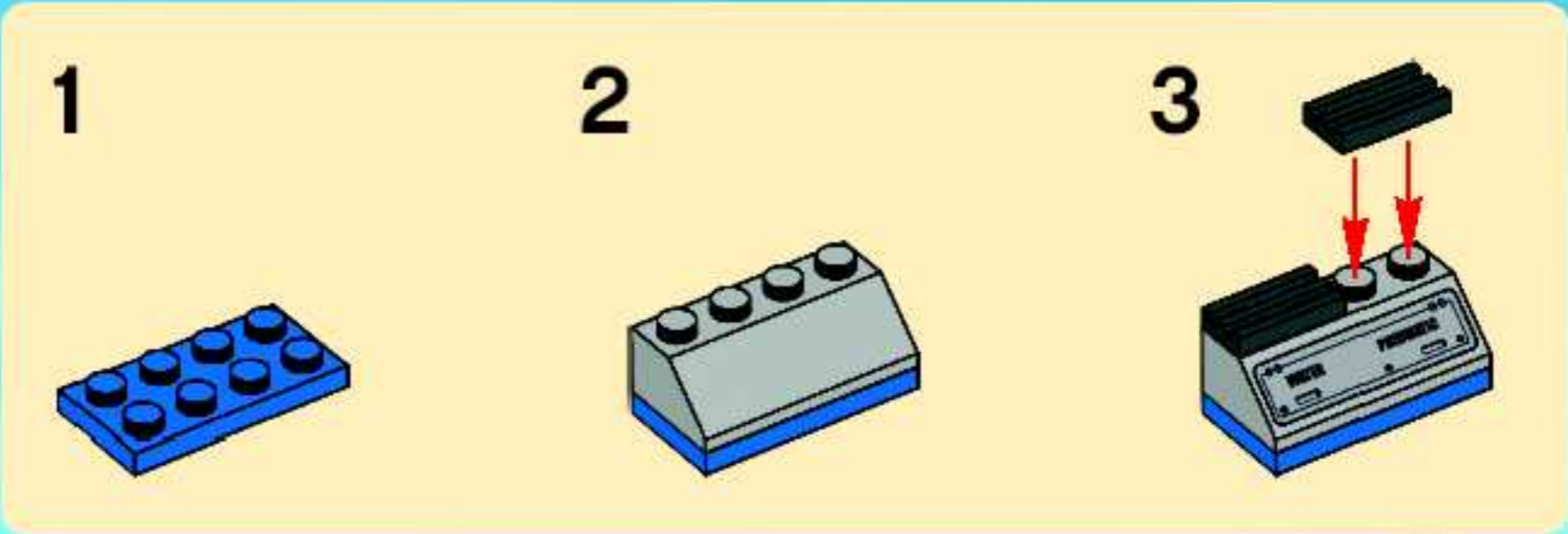

7

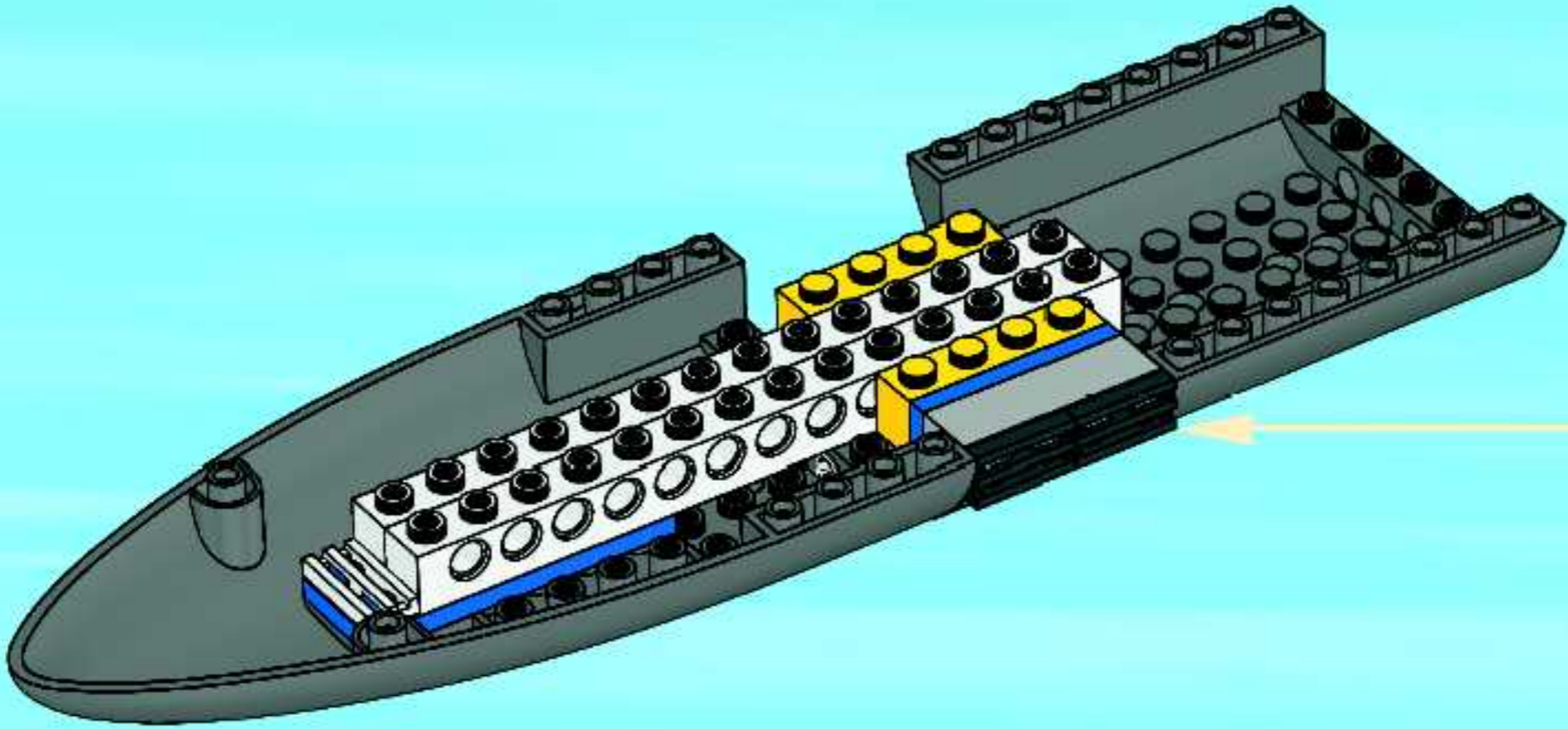

1



2



3

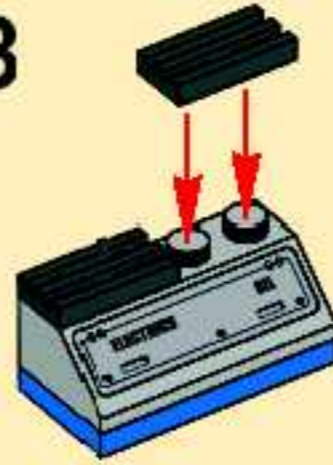

8

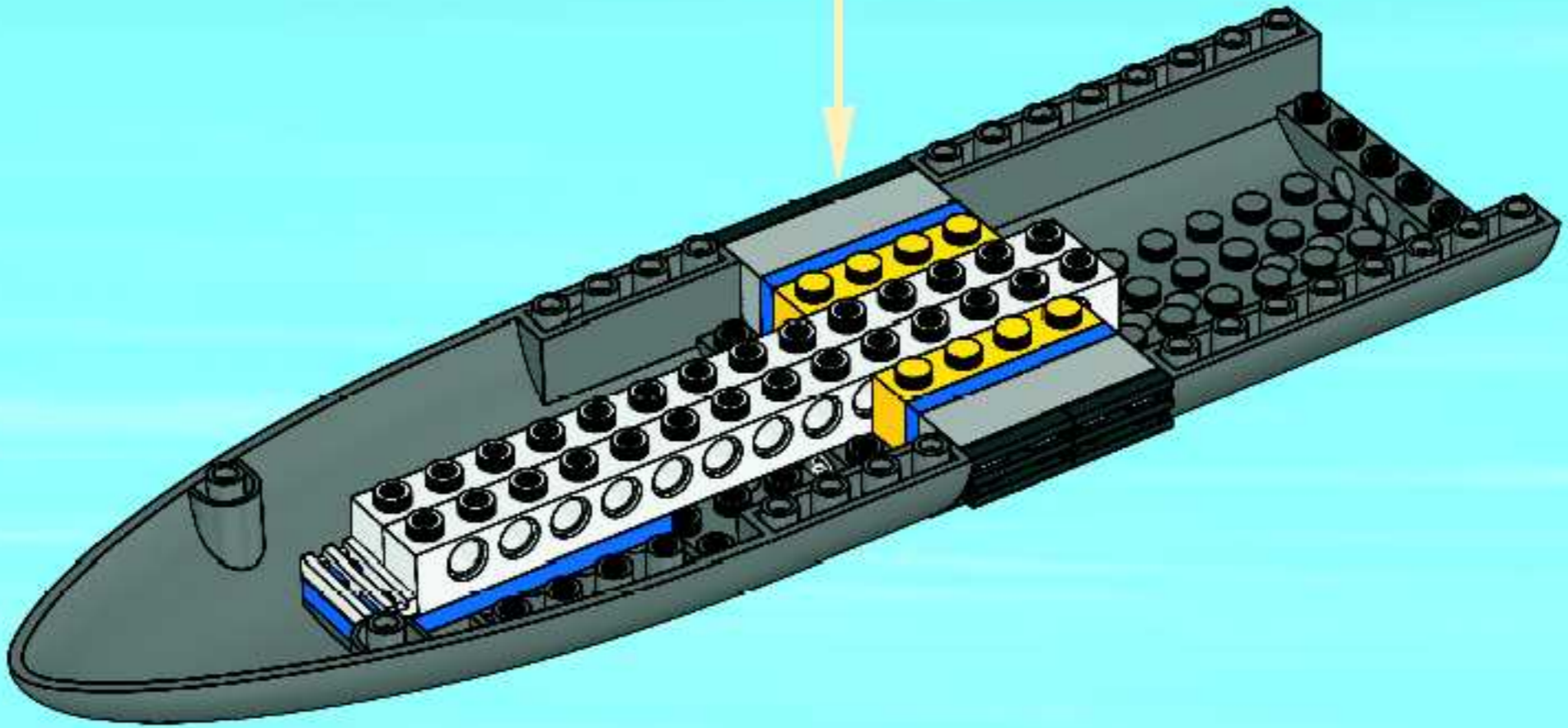

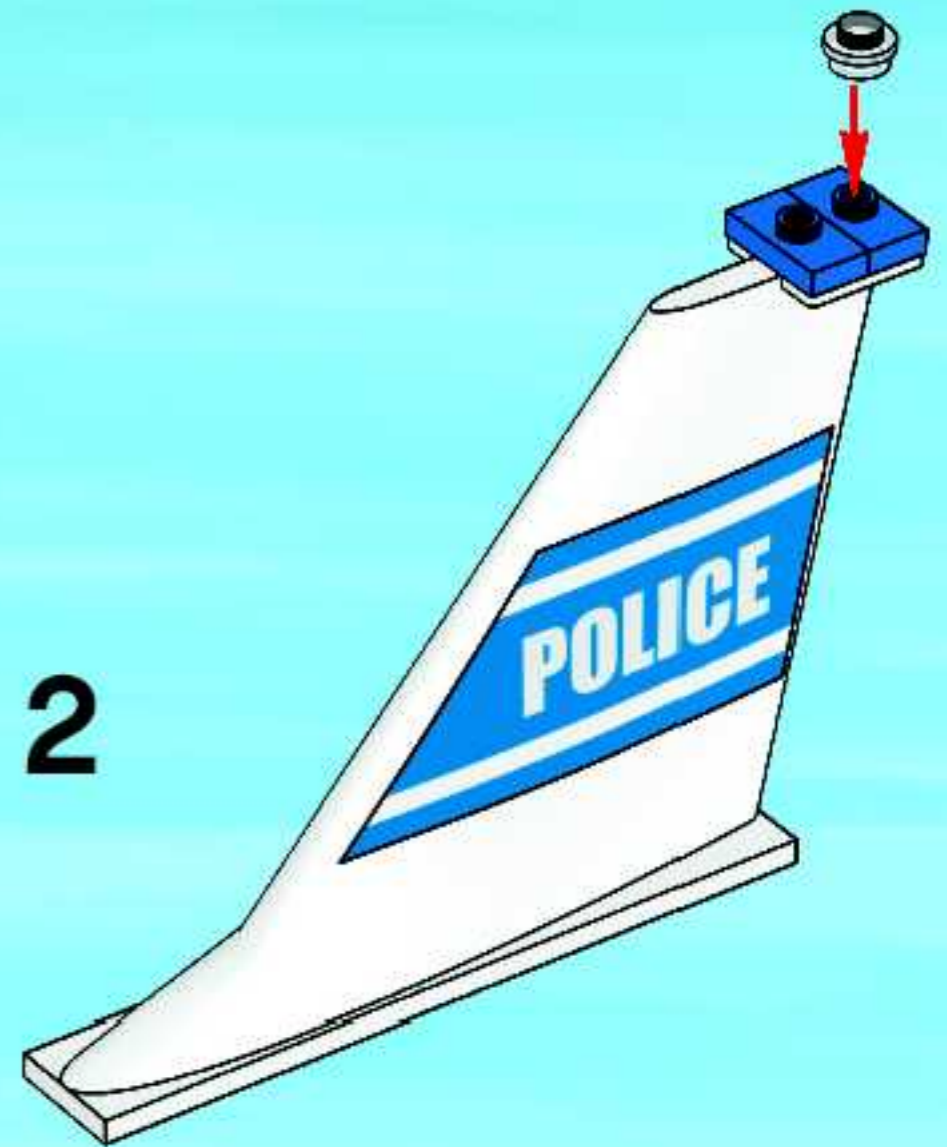
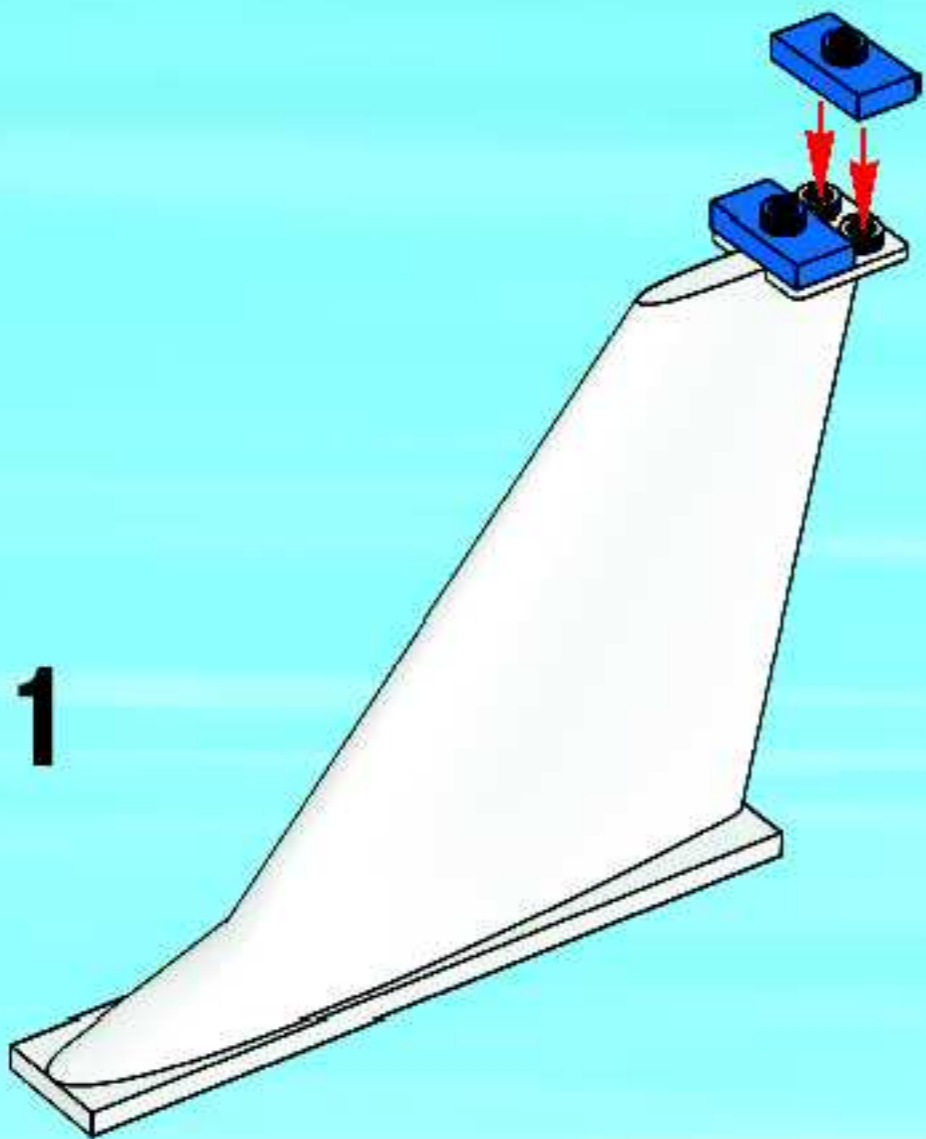

3

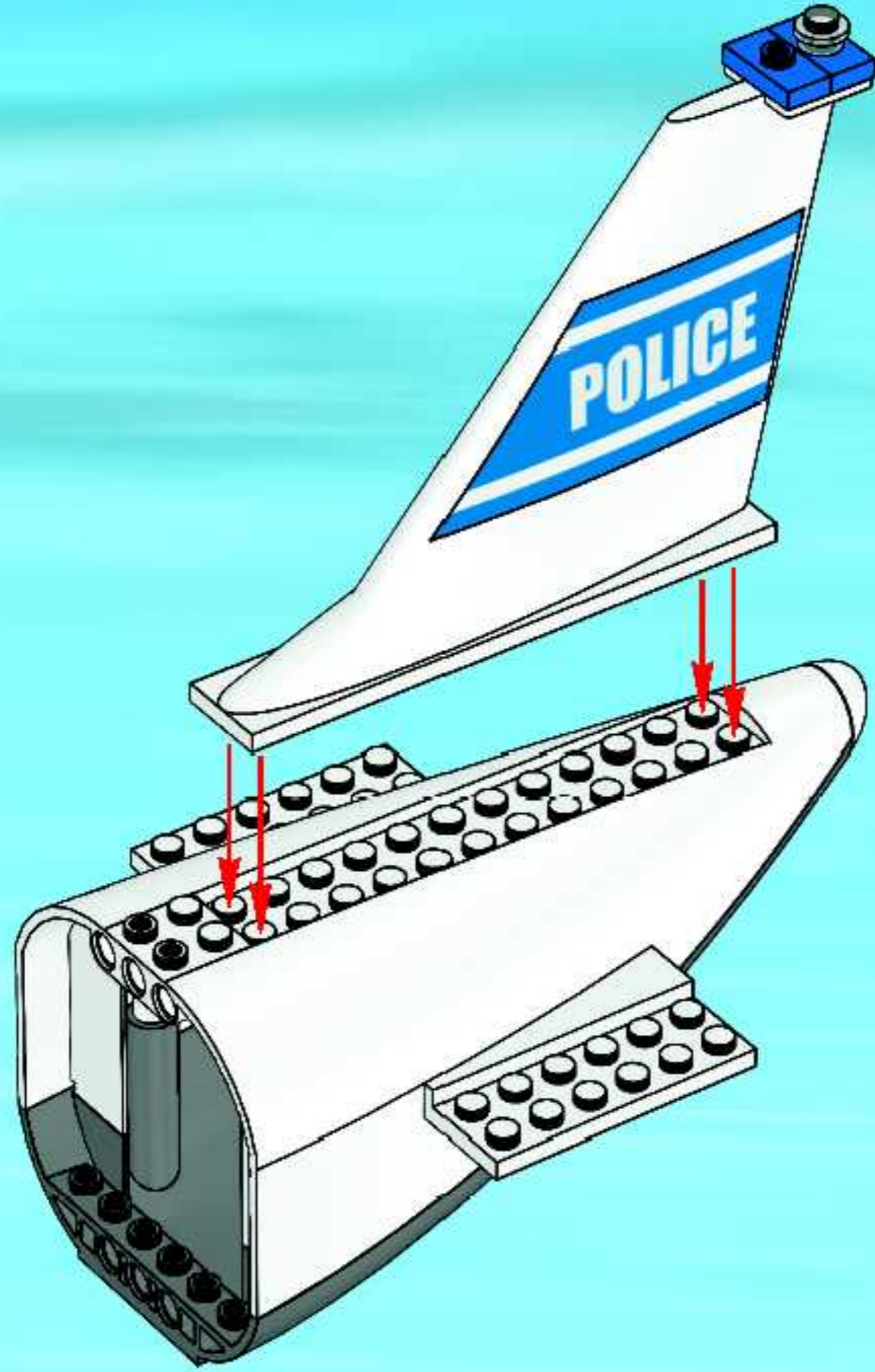

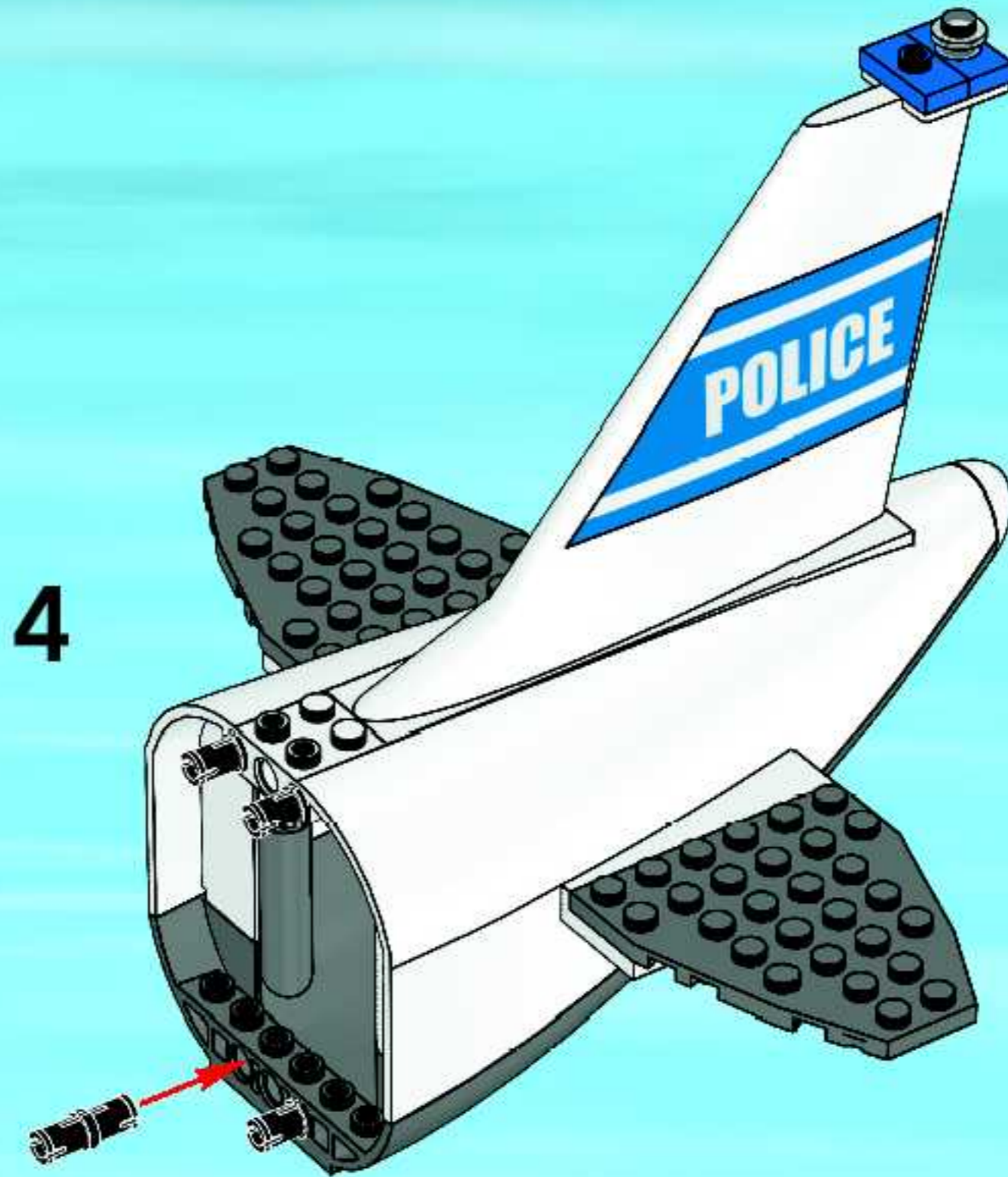

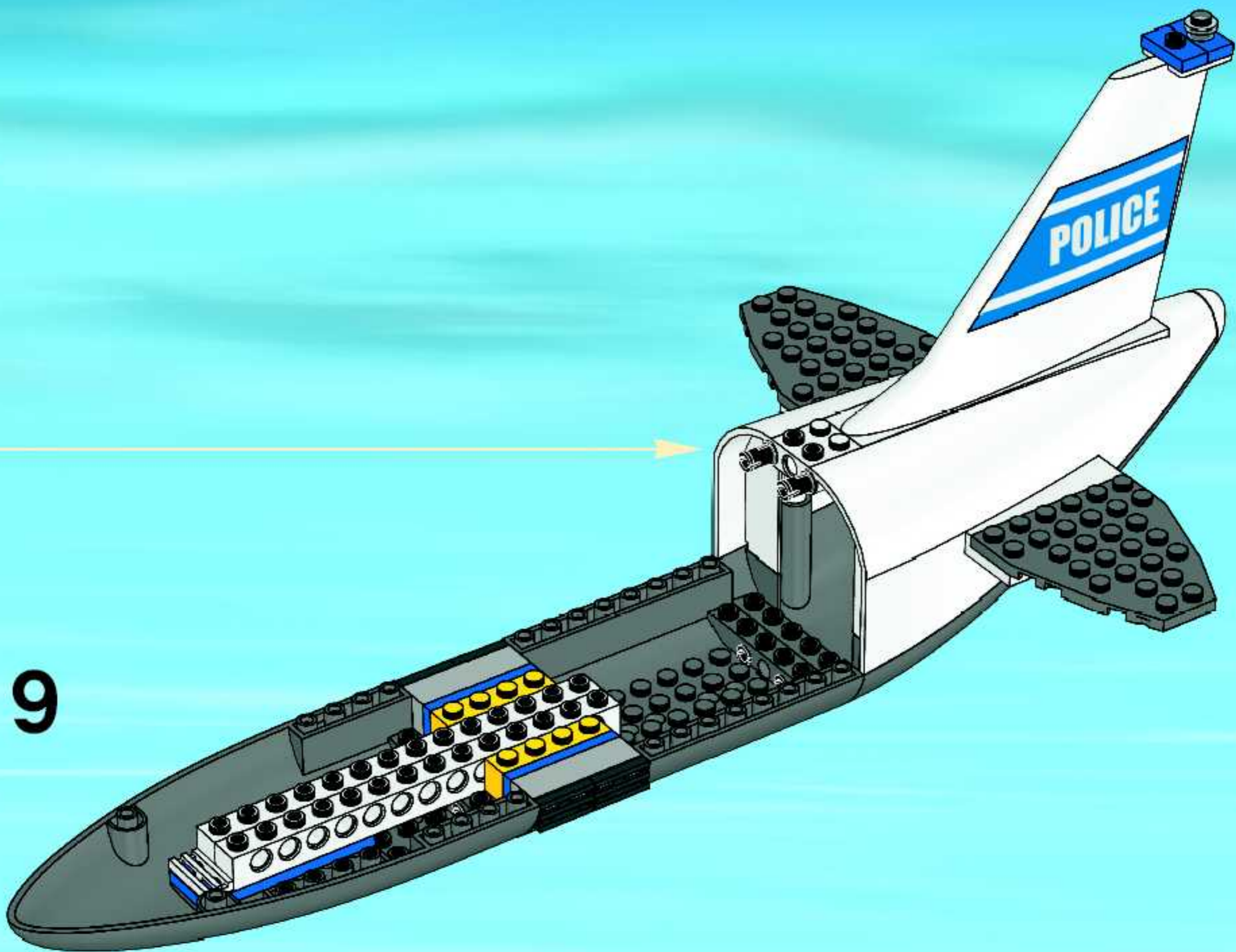

10

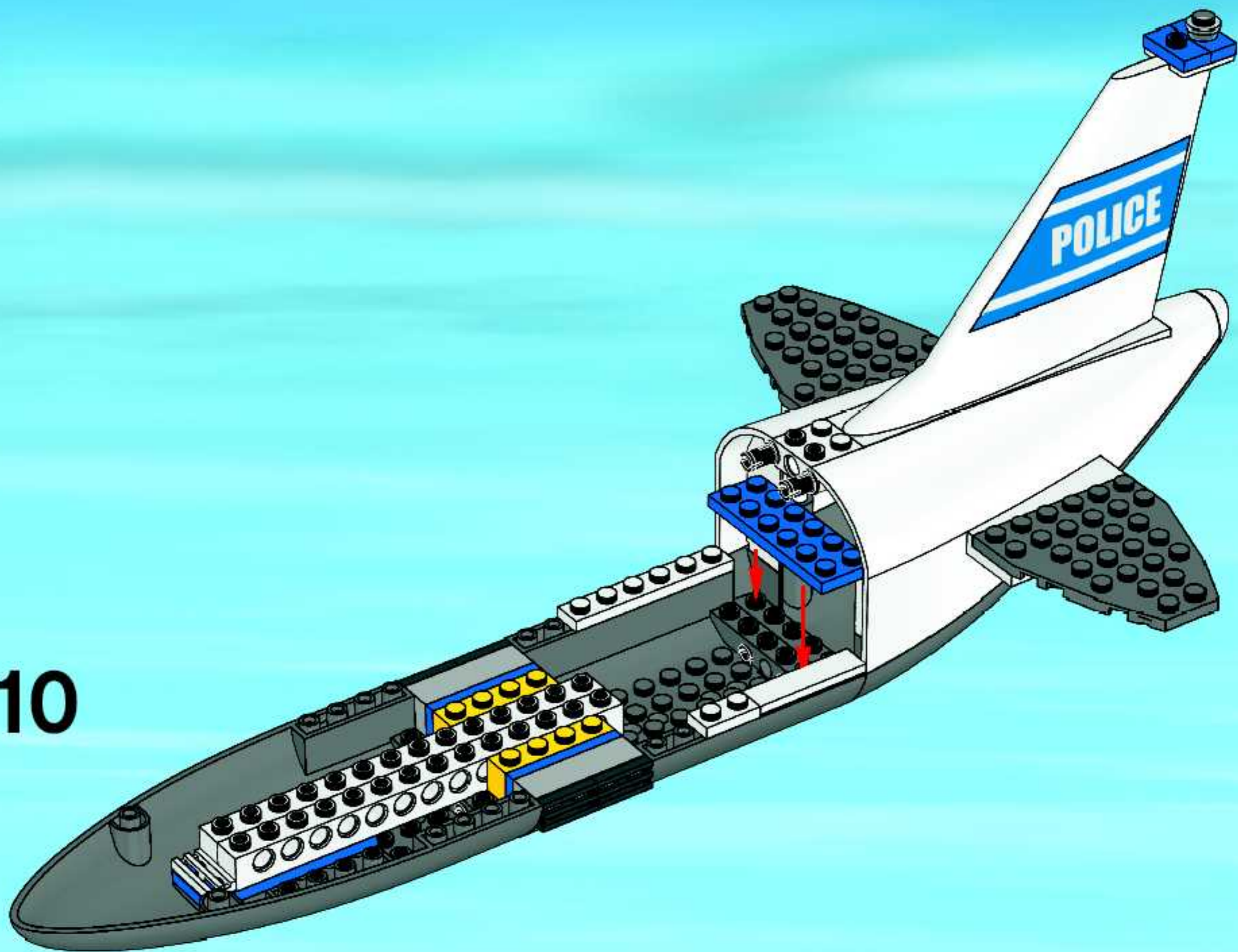

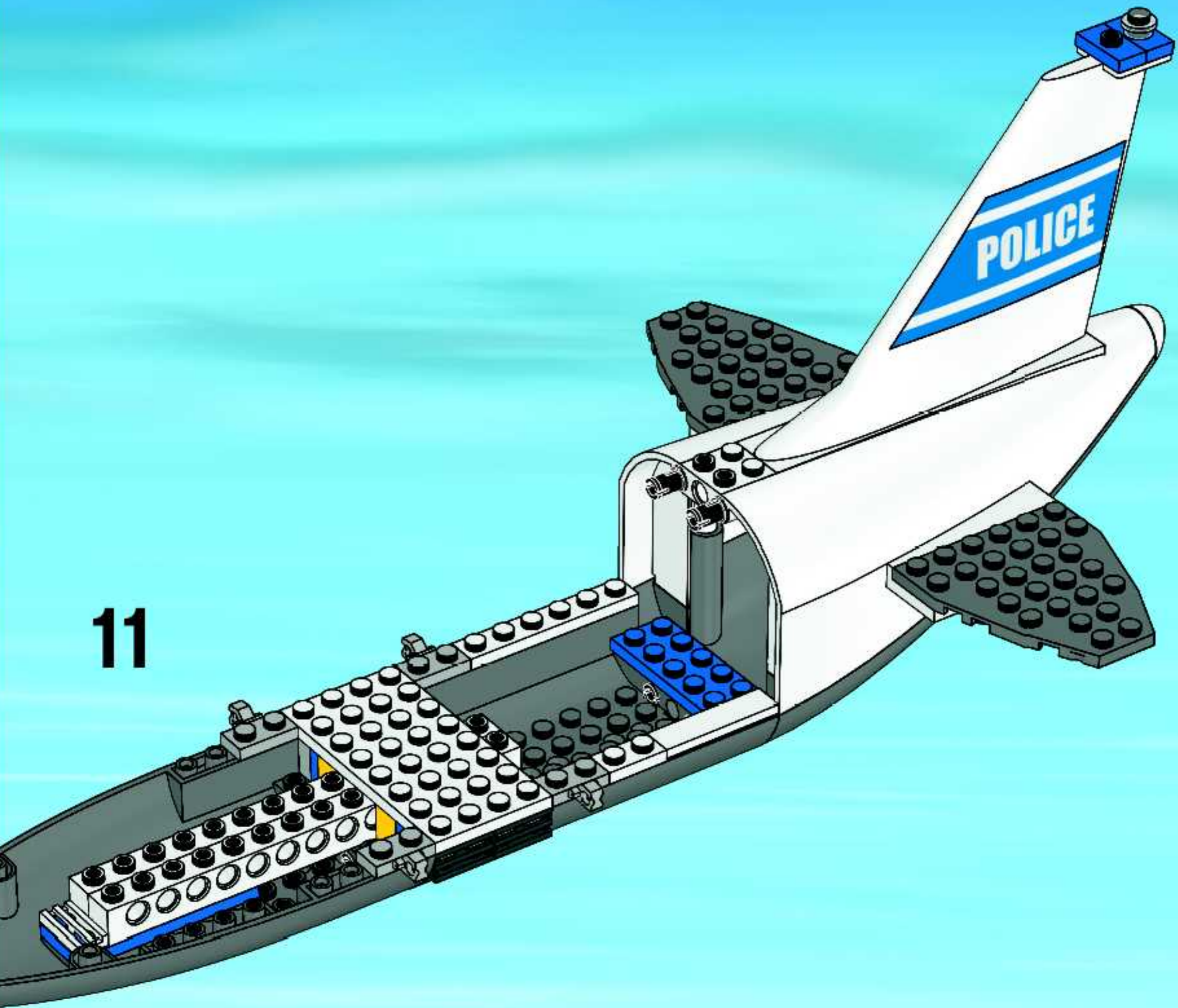

11

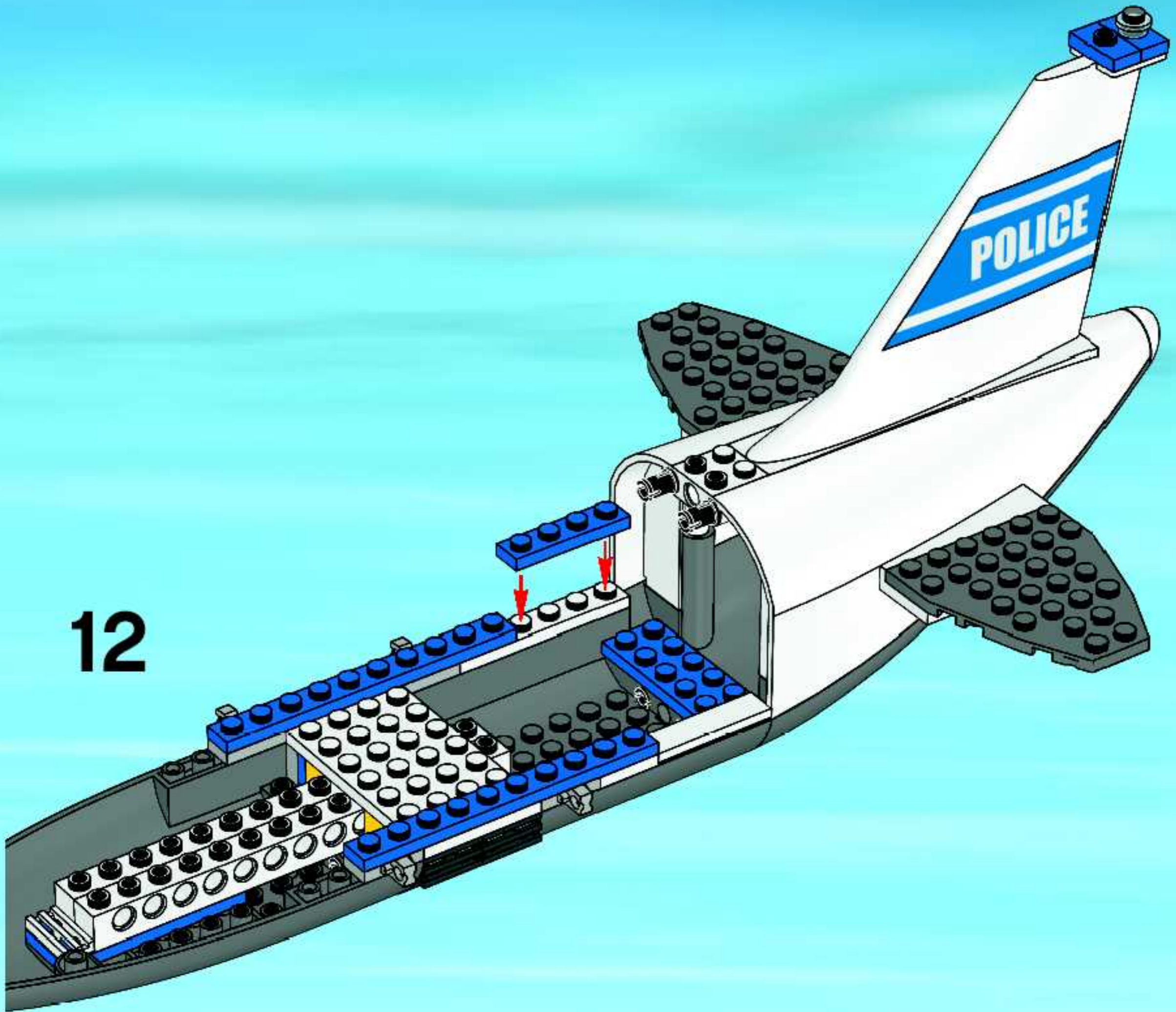

12

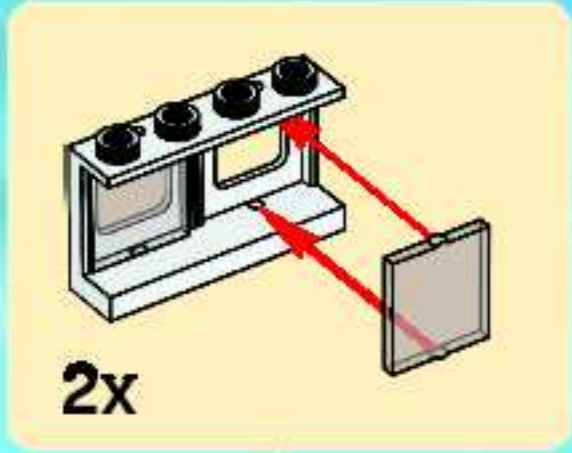

13

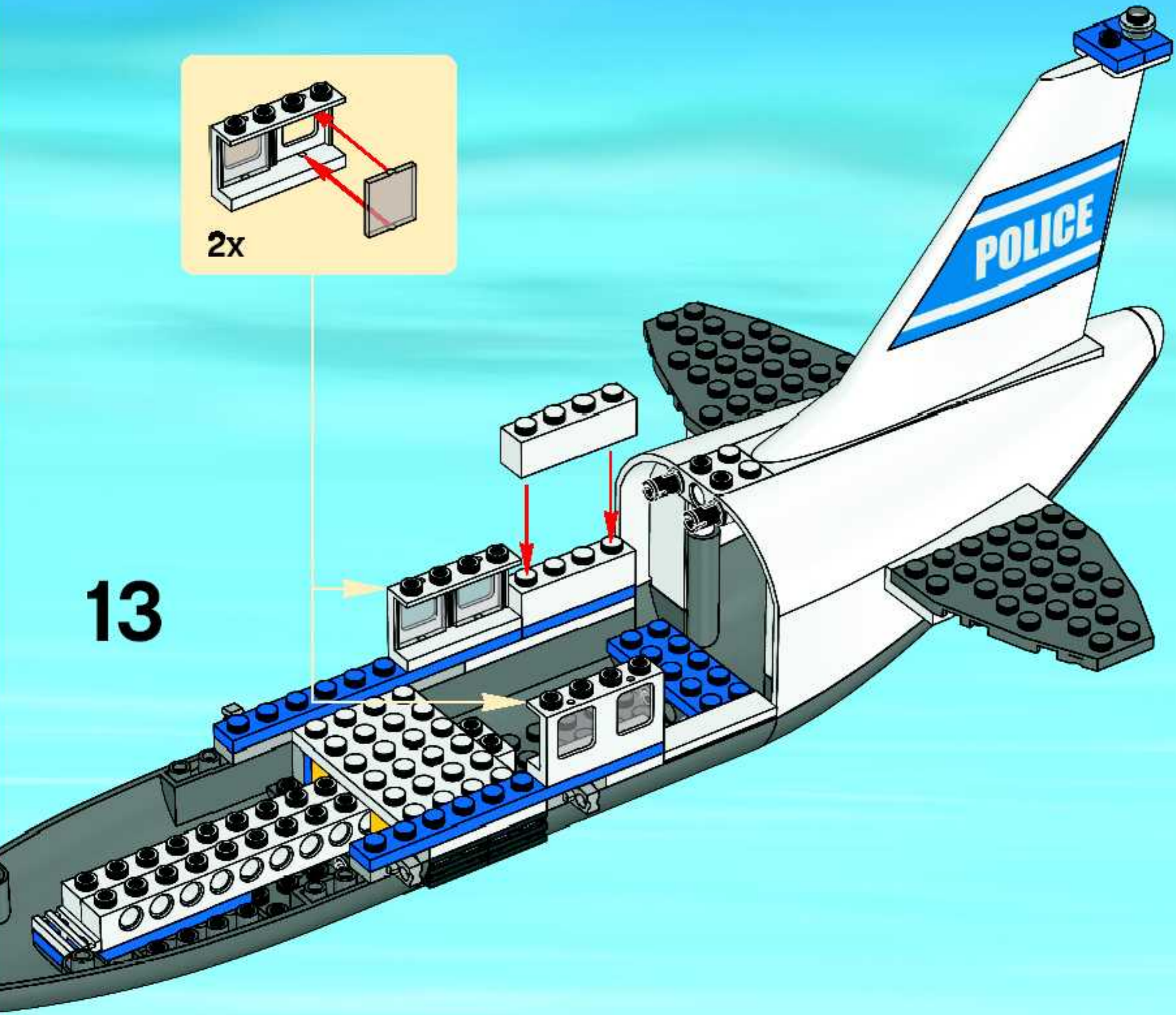

14

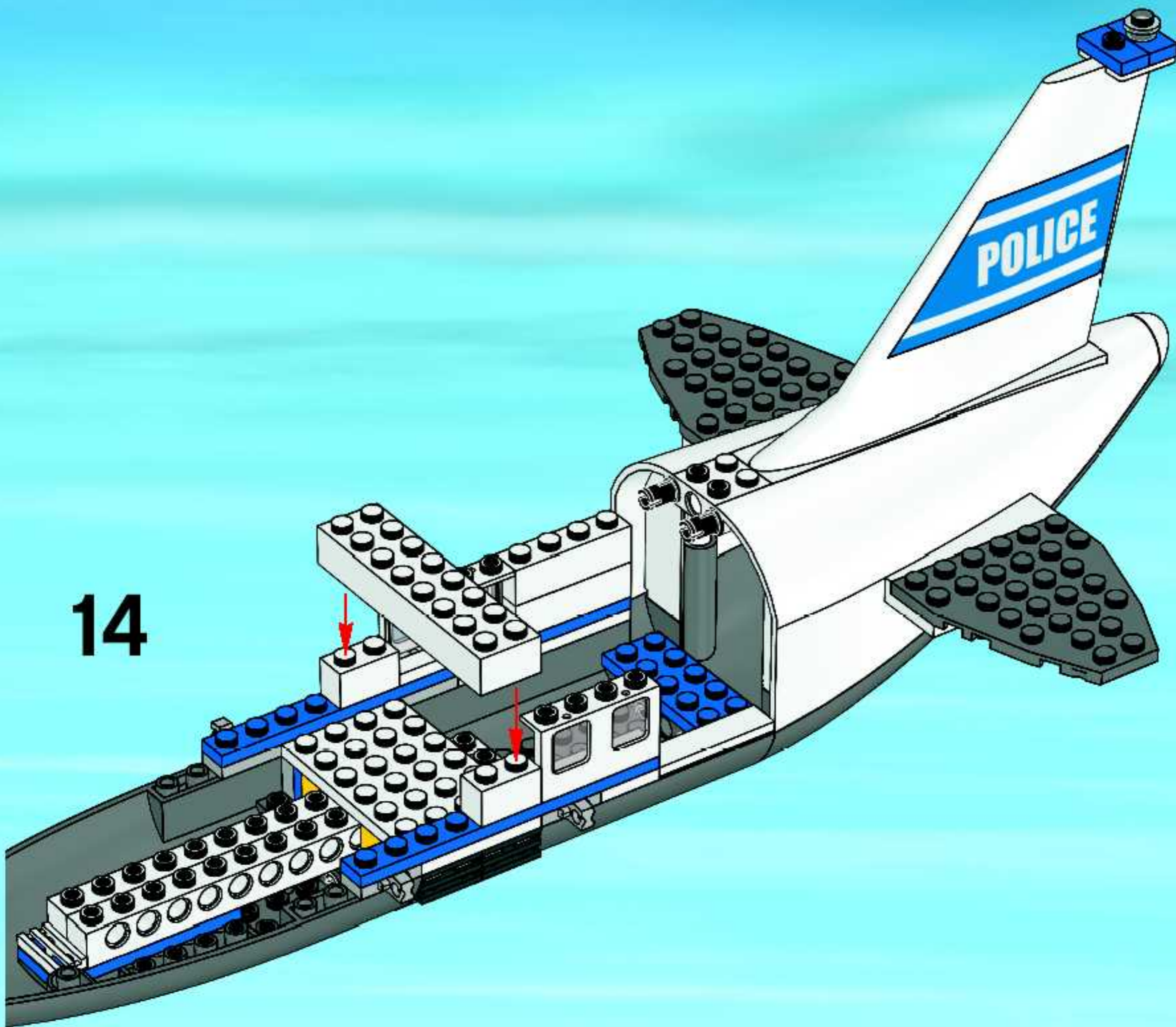

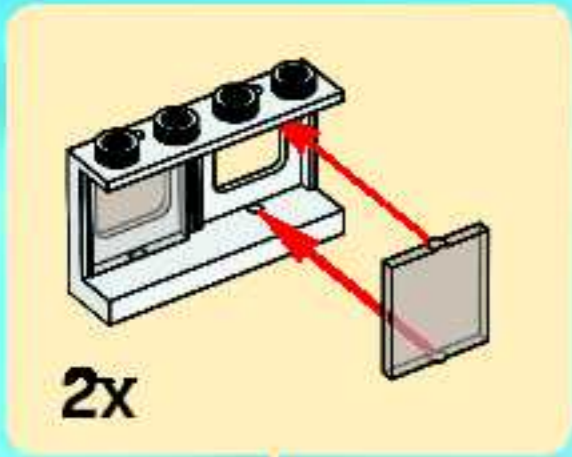

15

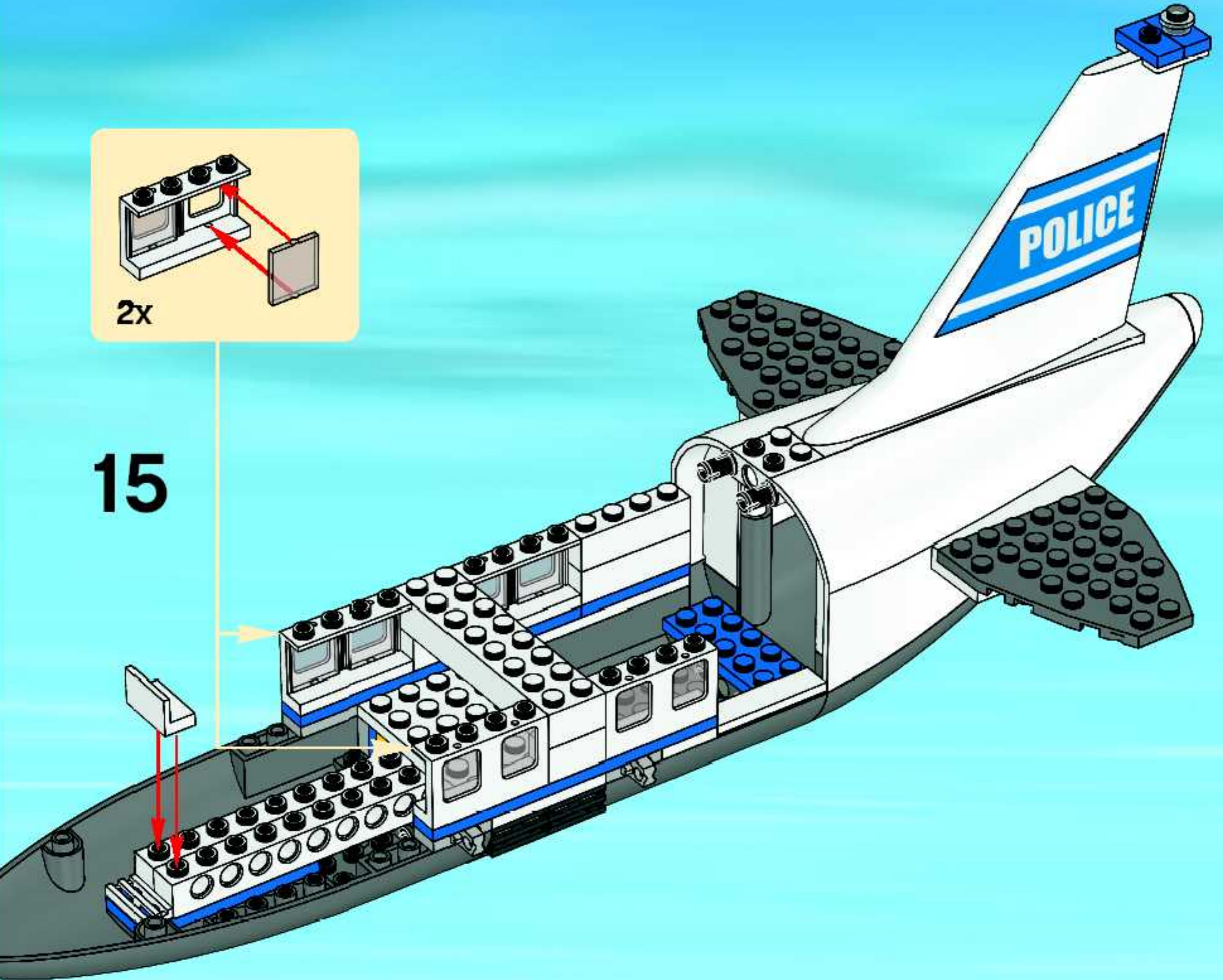

16

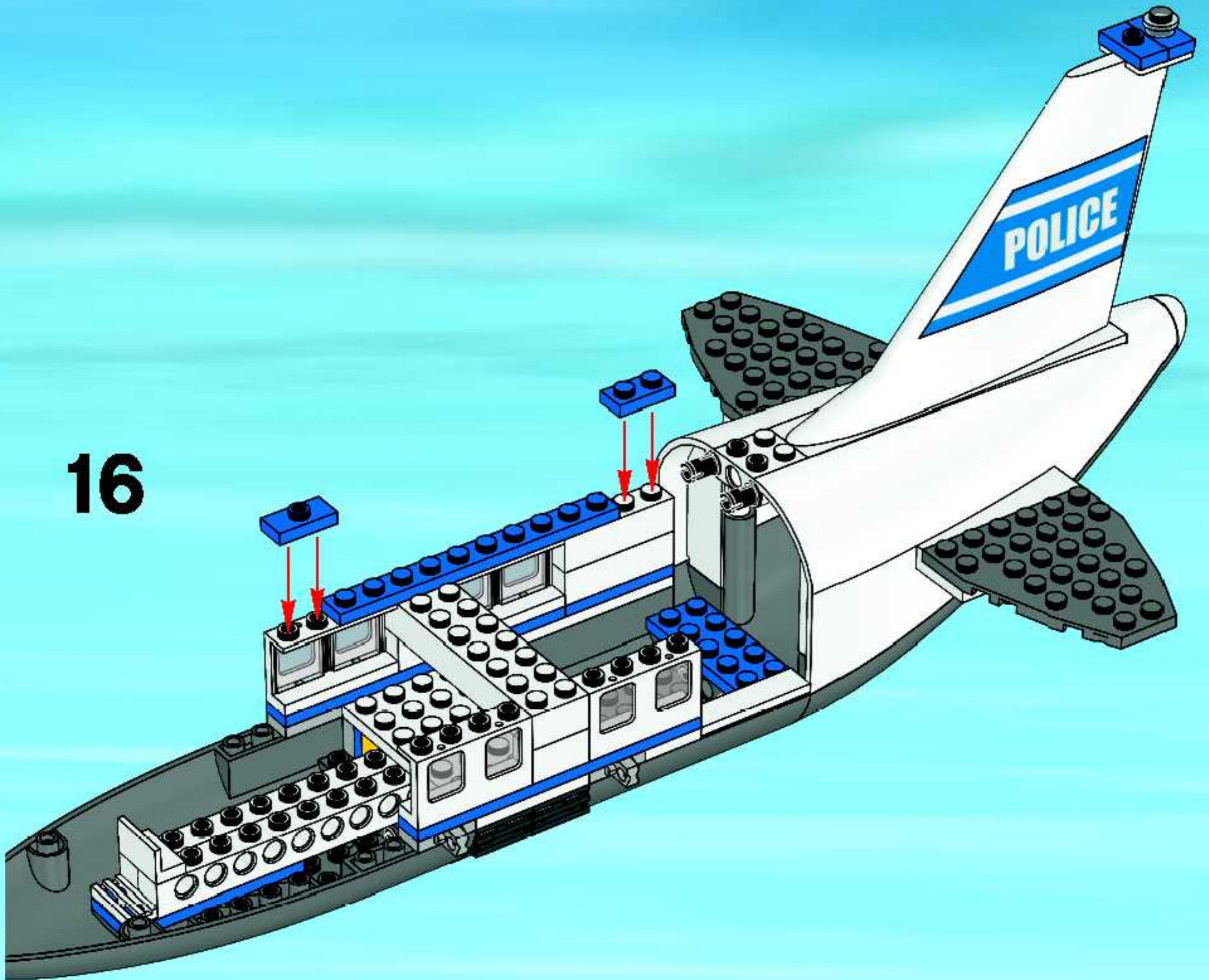

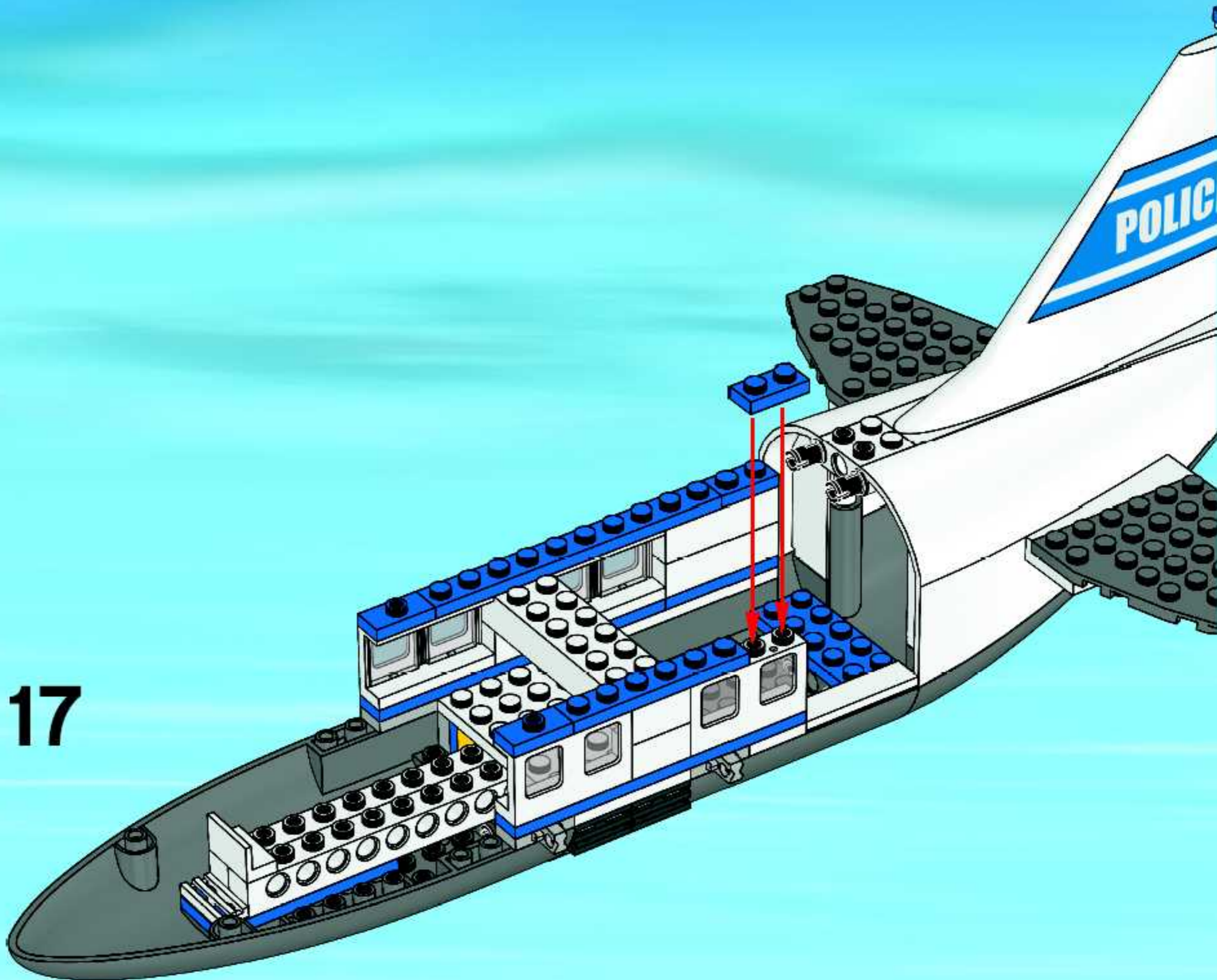

17

18

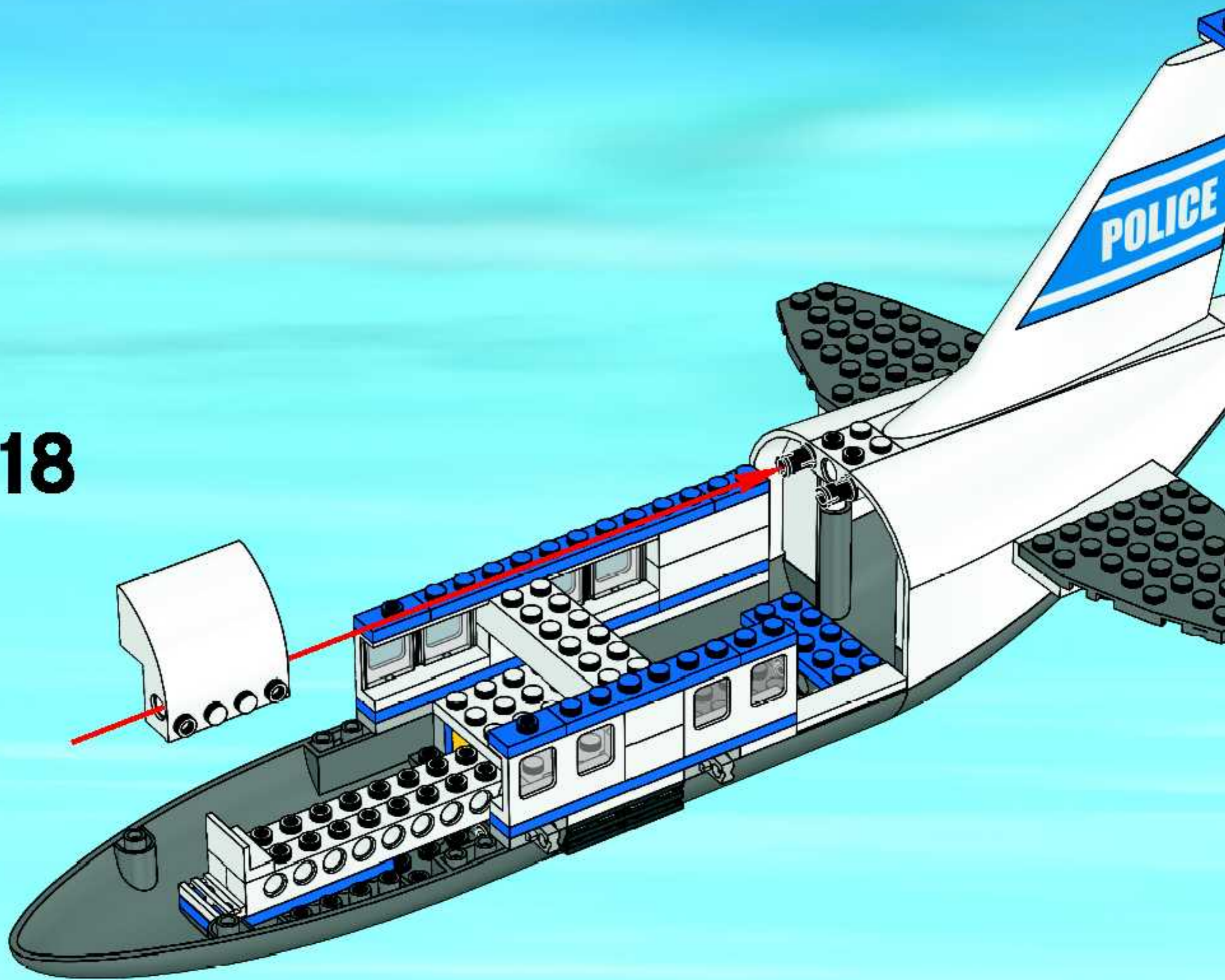



1

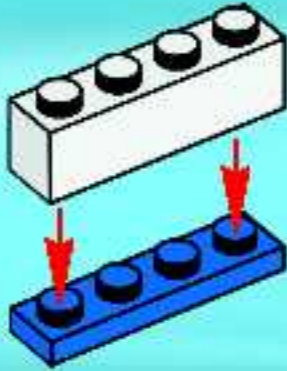

2

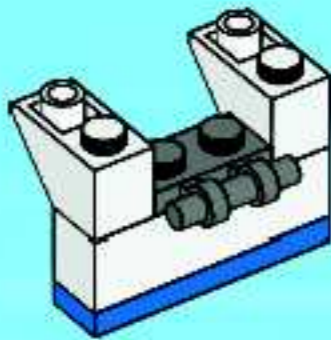

3

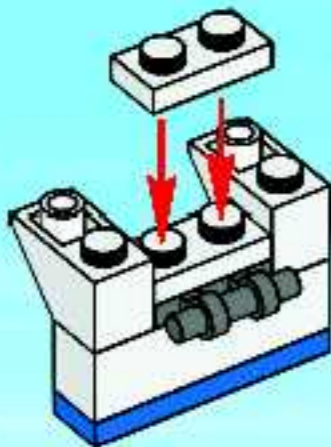

4

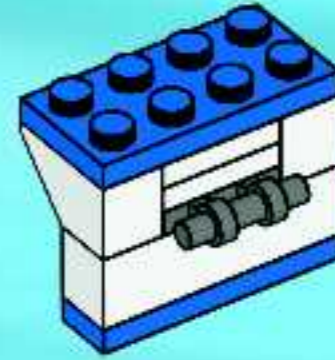

5

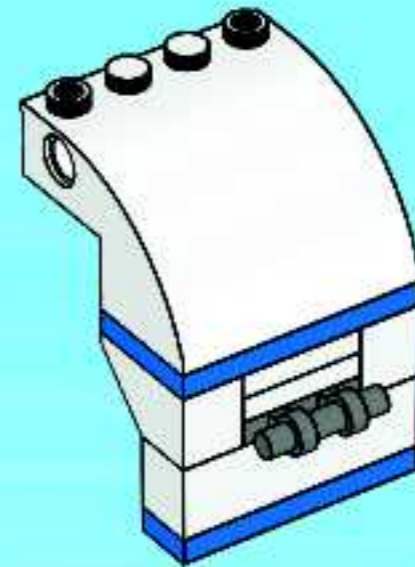

19

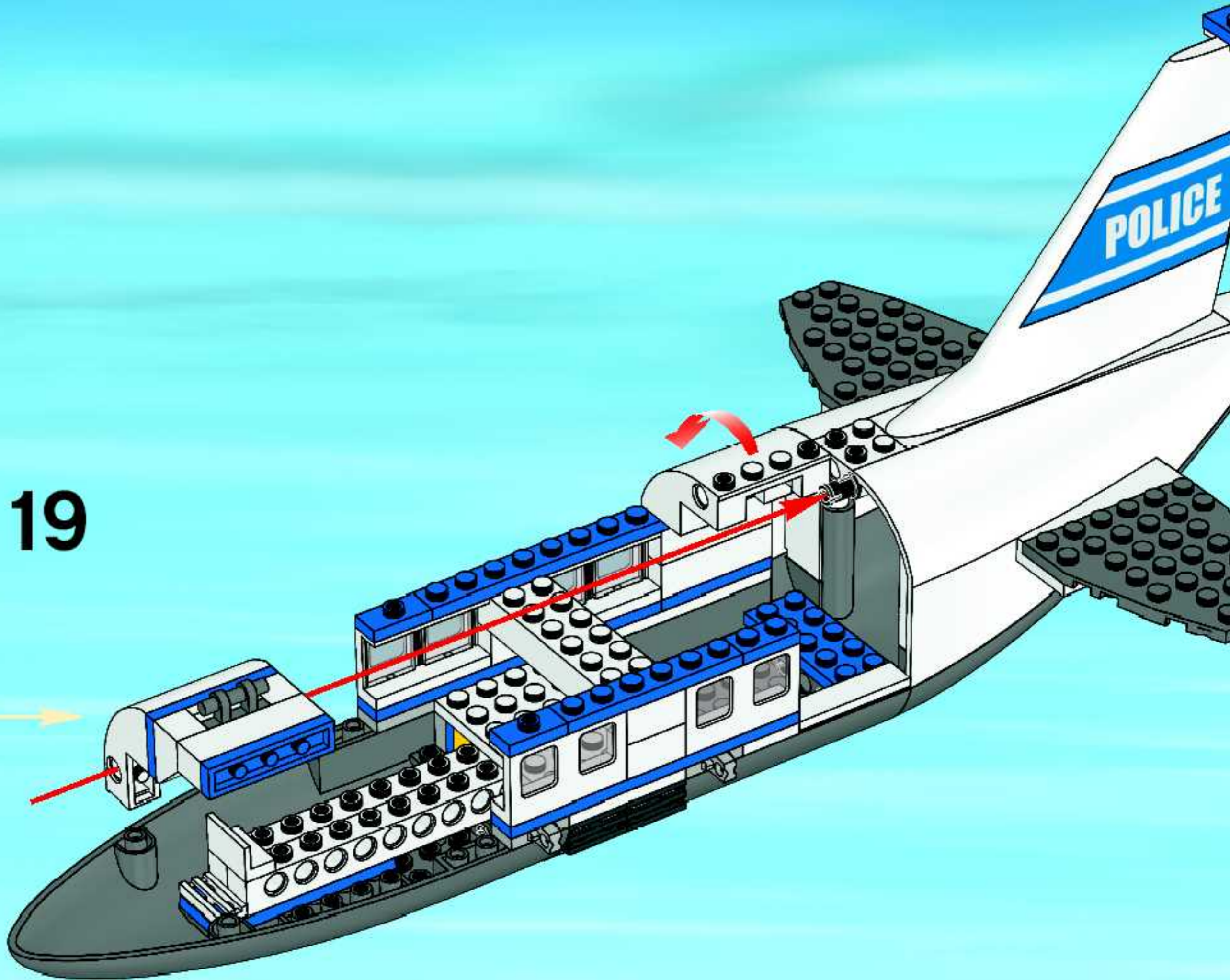

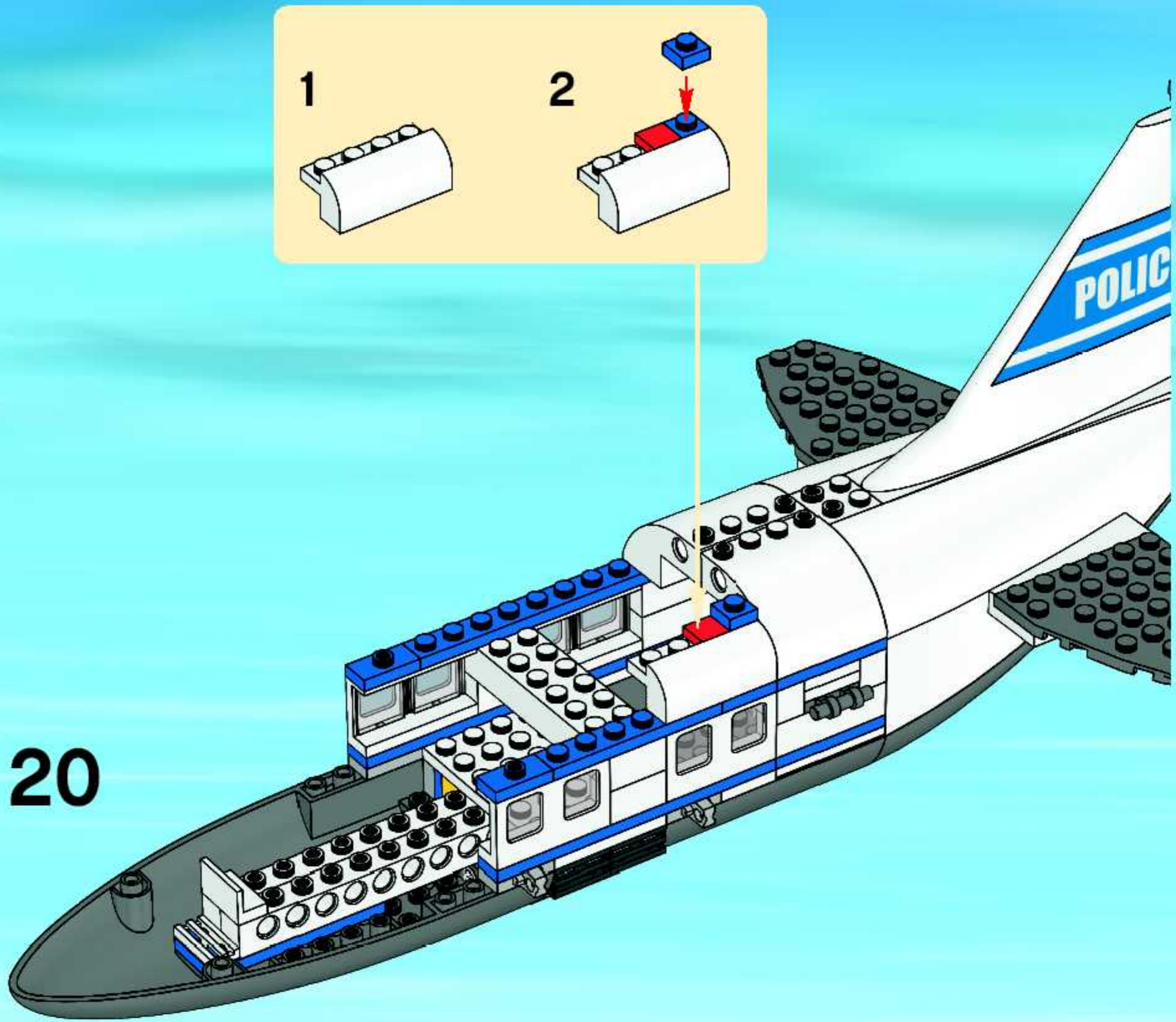

20

1

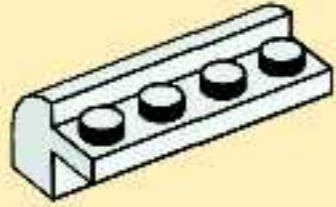

2

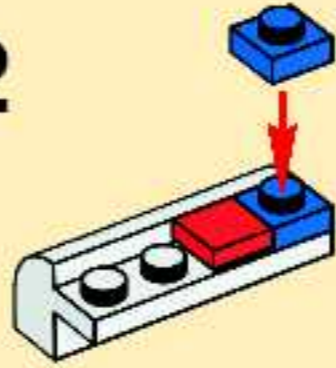

21

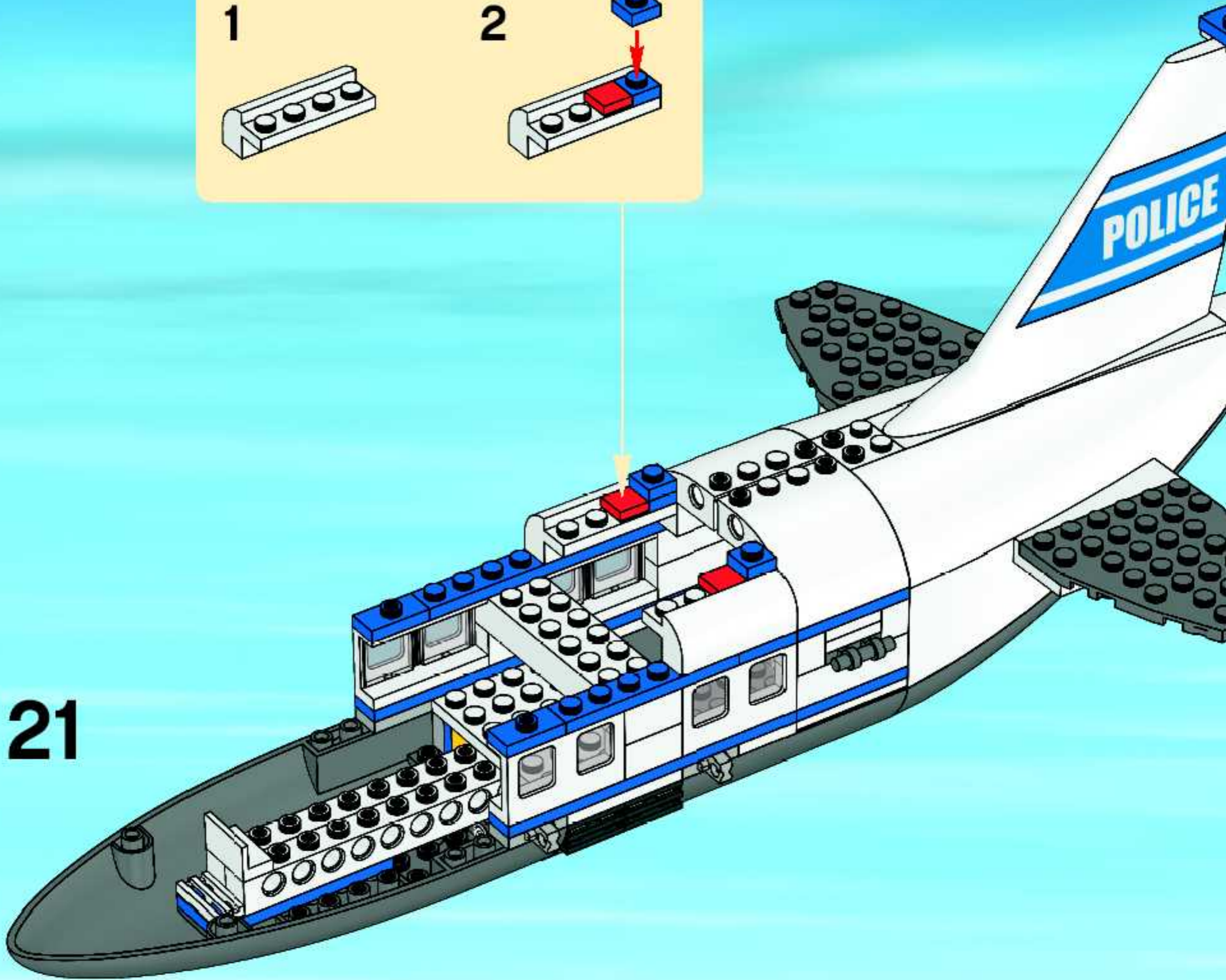

22

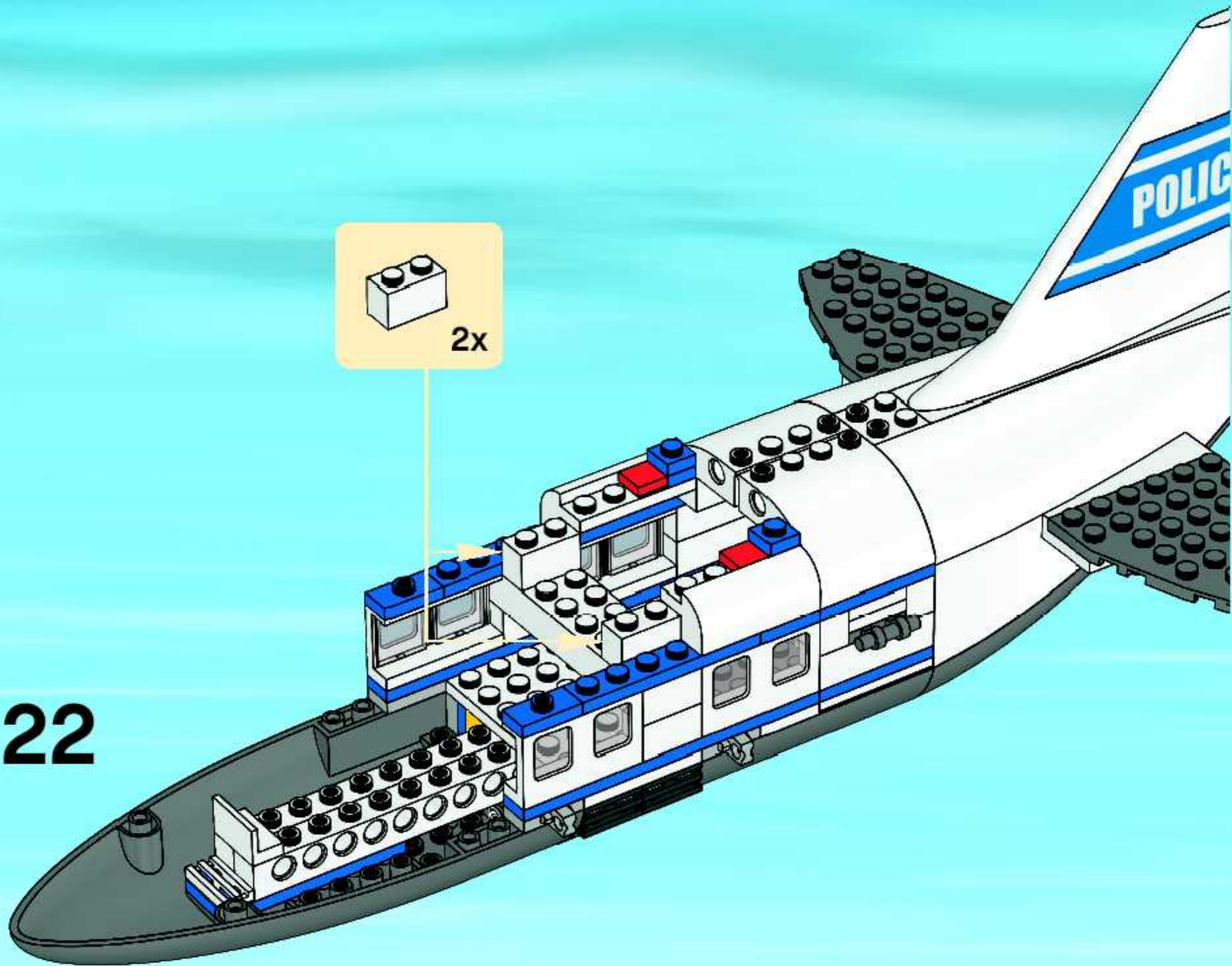
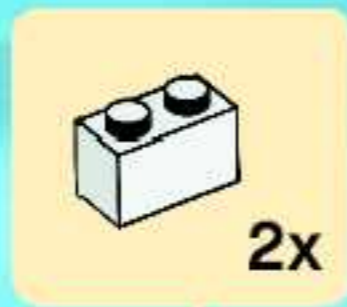

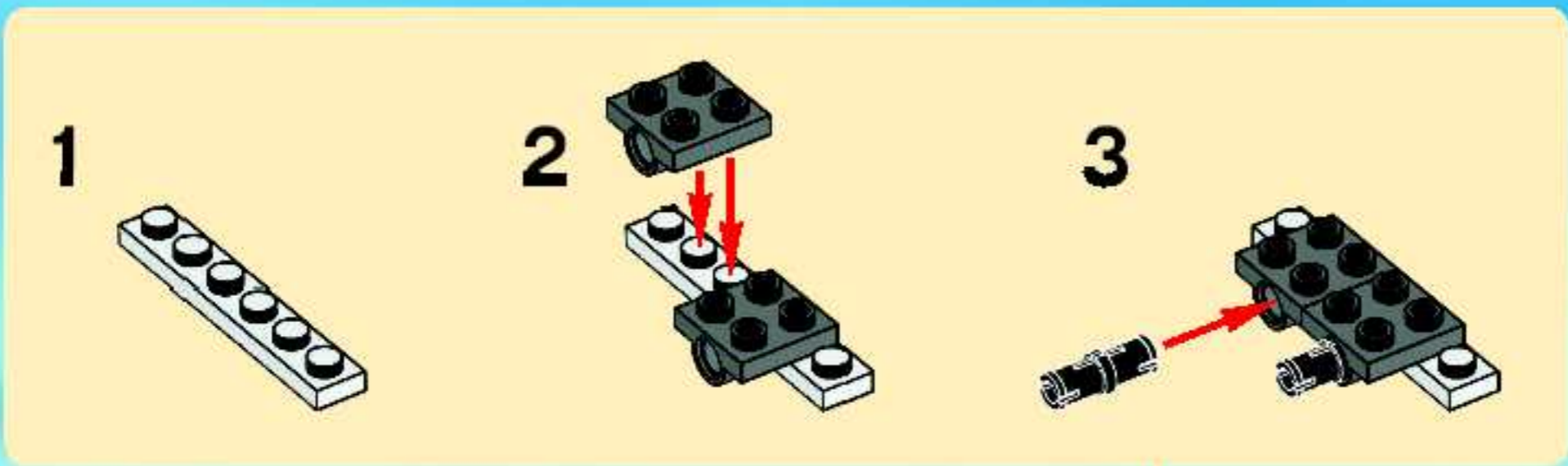

23

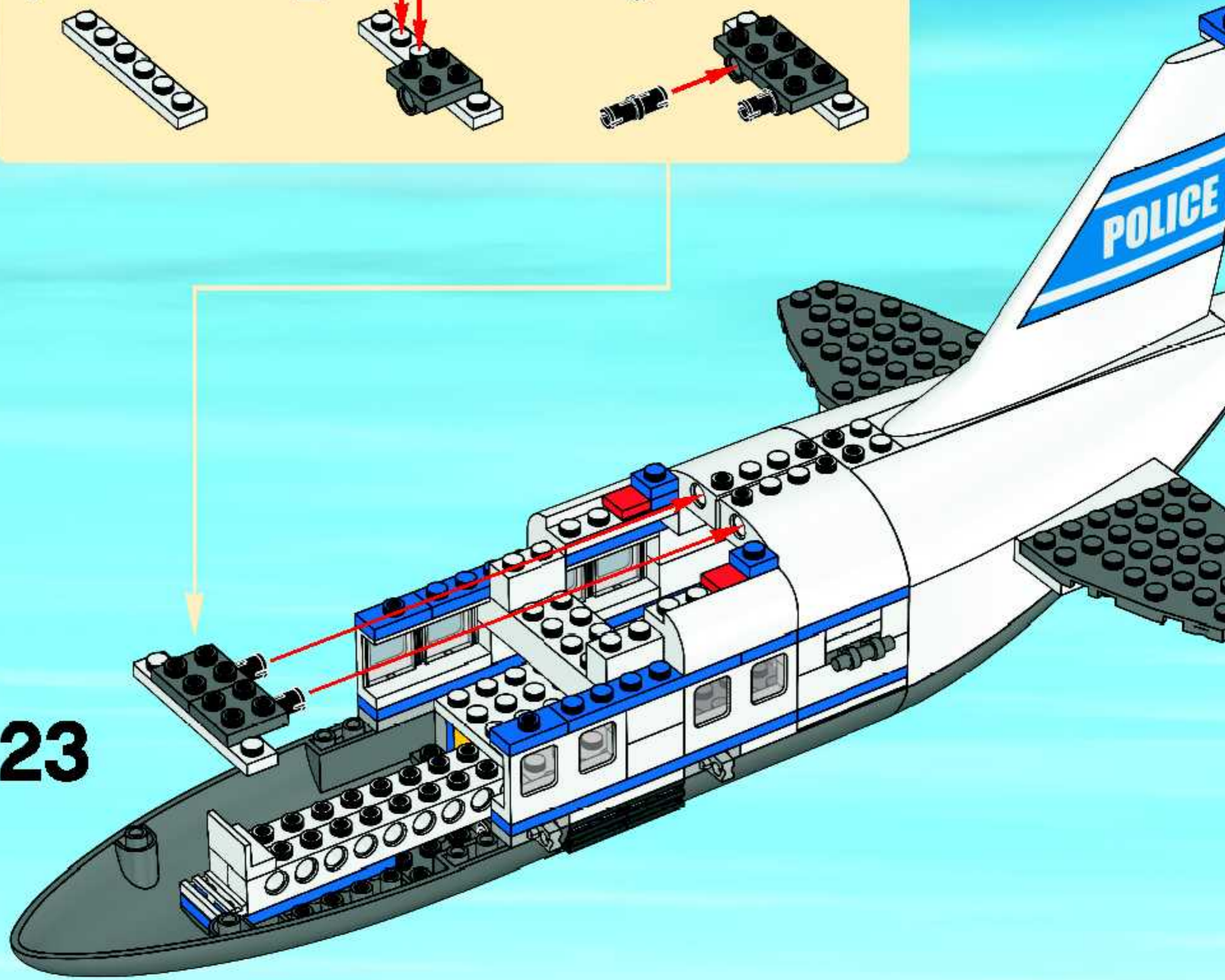

1

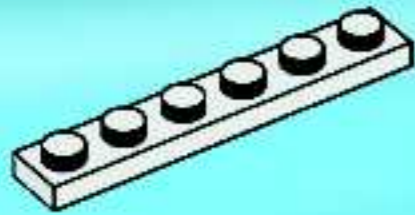

2

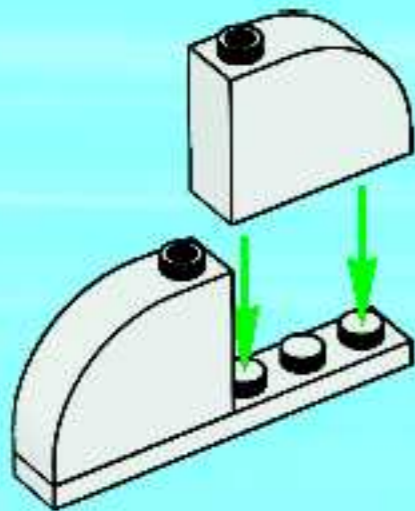

3

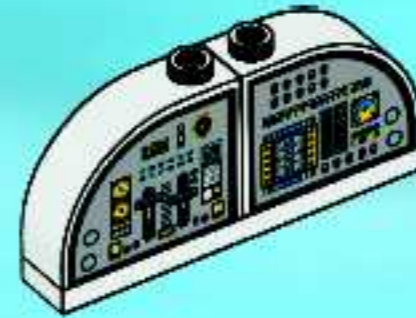

4

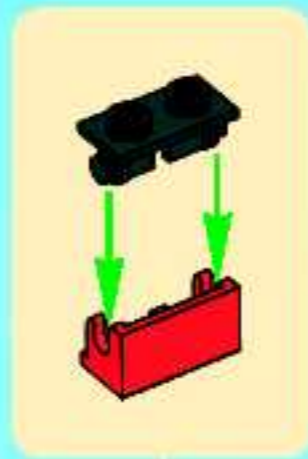

24

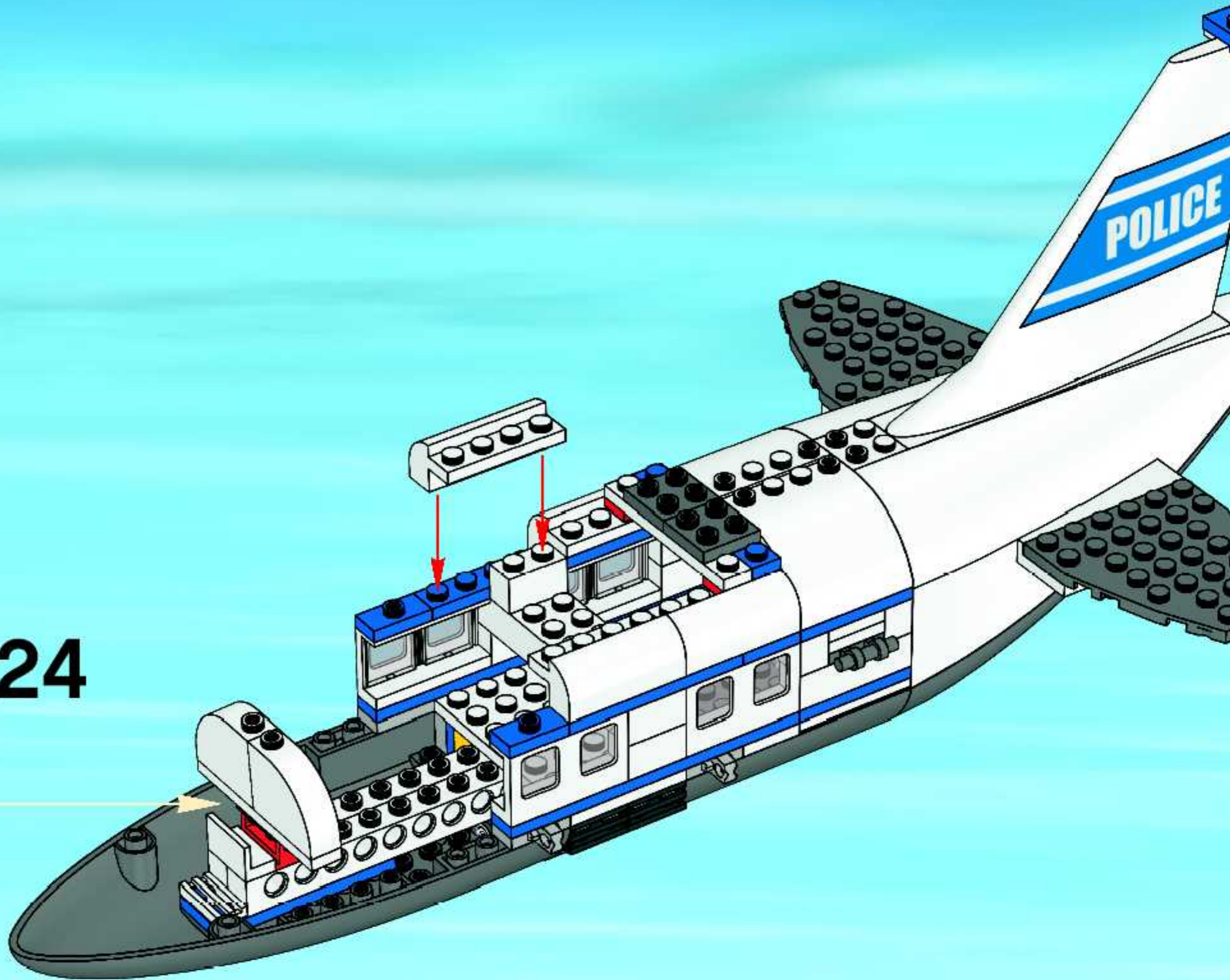

1



2

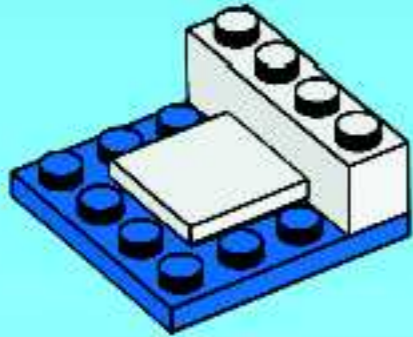

3

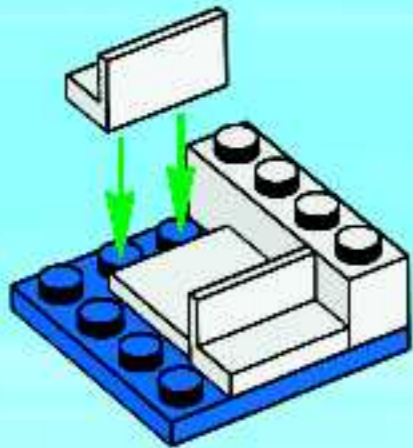

4

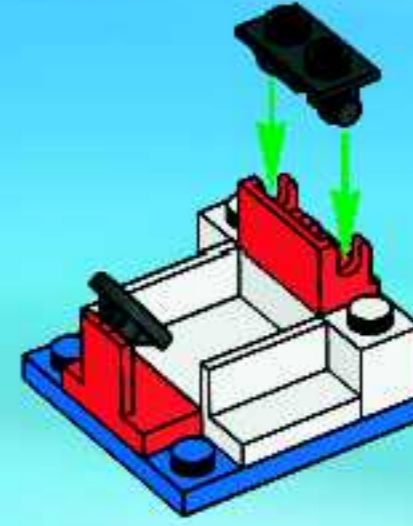

5

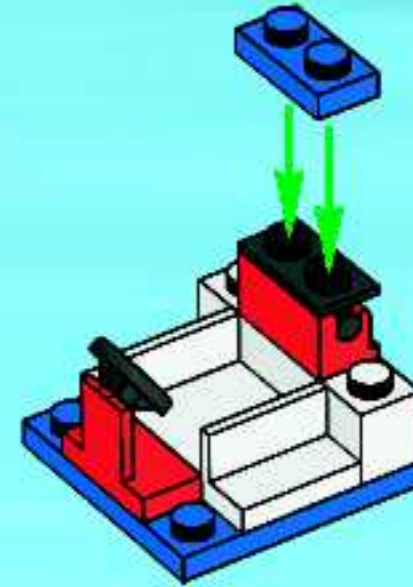

6

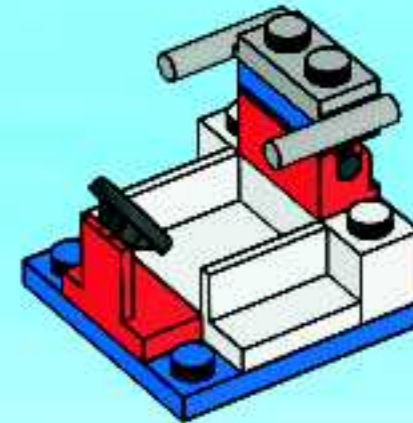

7

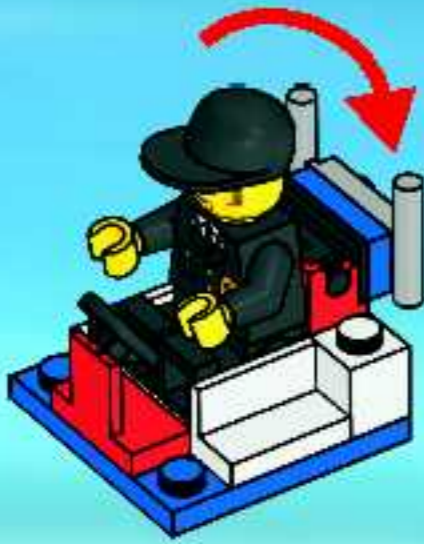

8

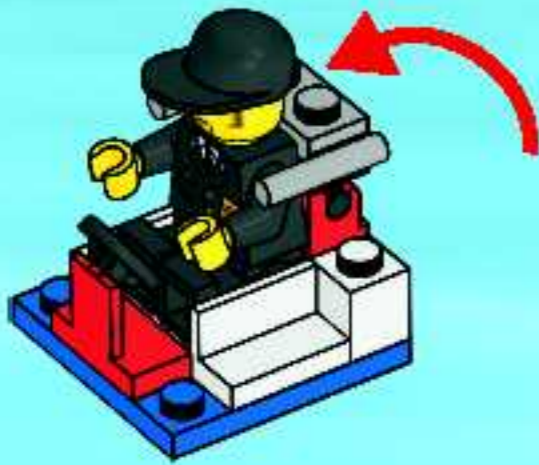

25

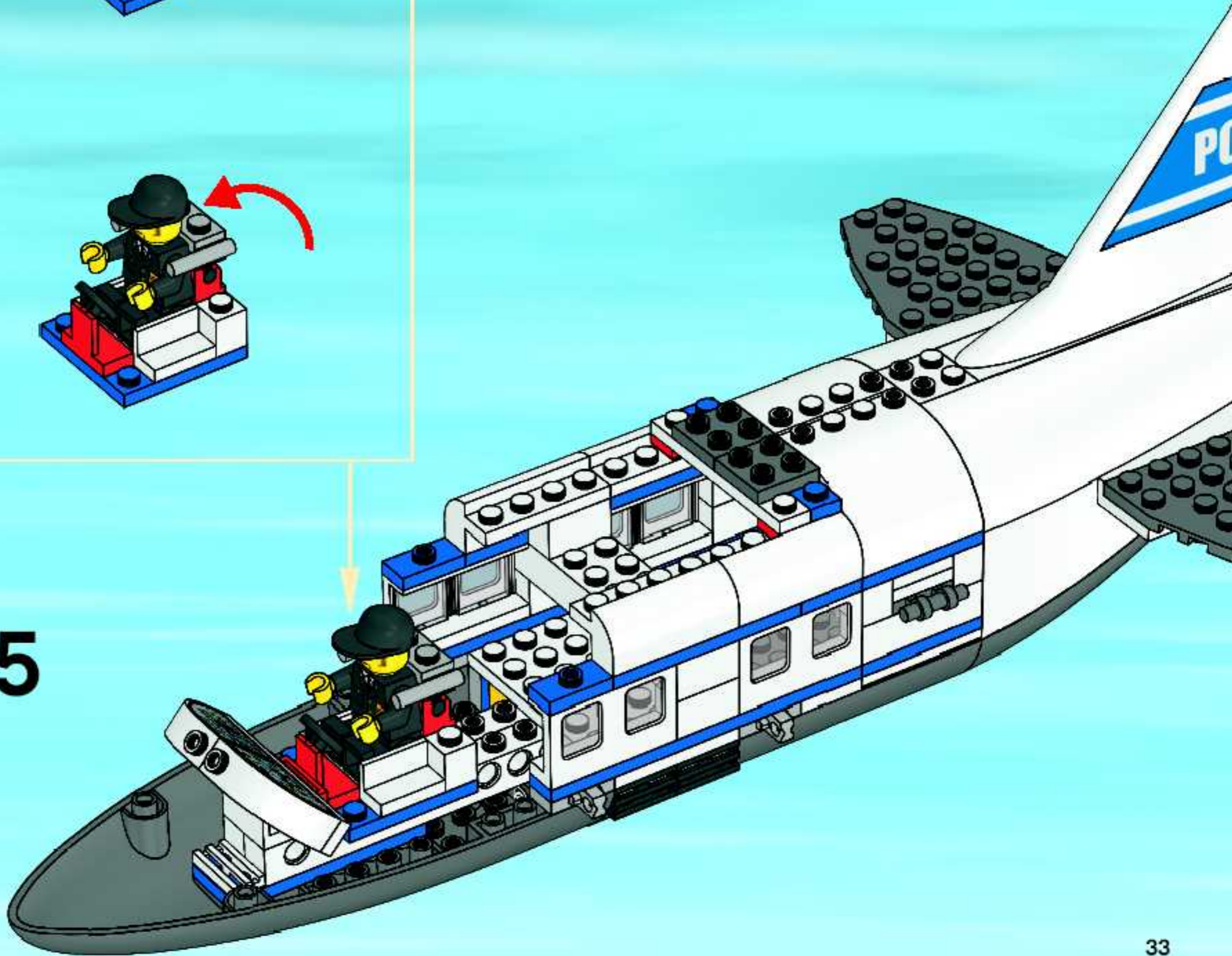

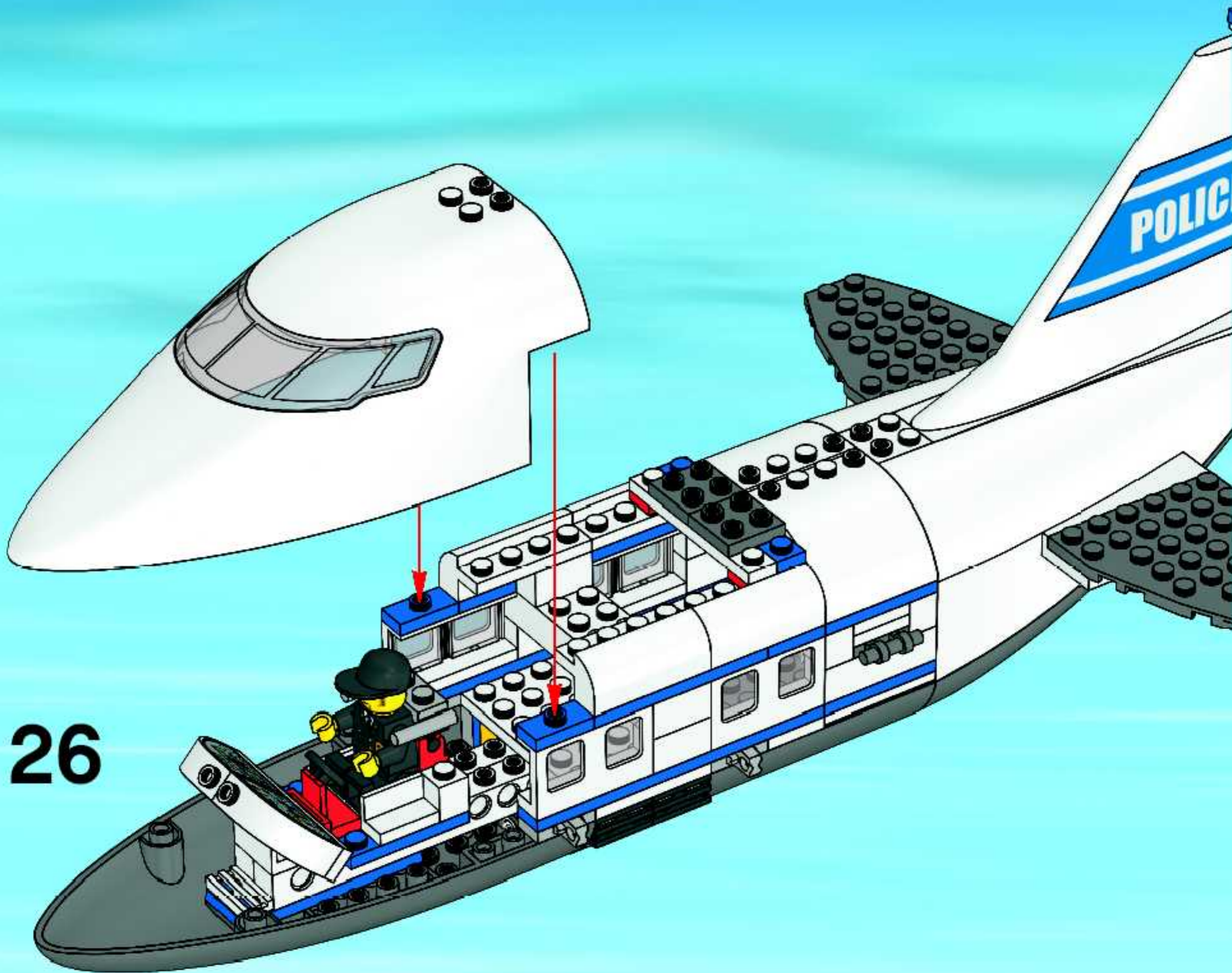

26

27

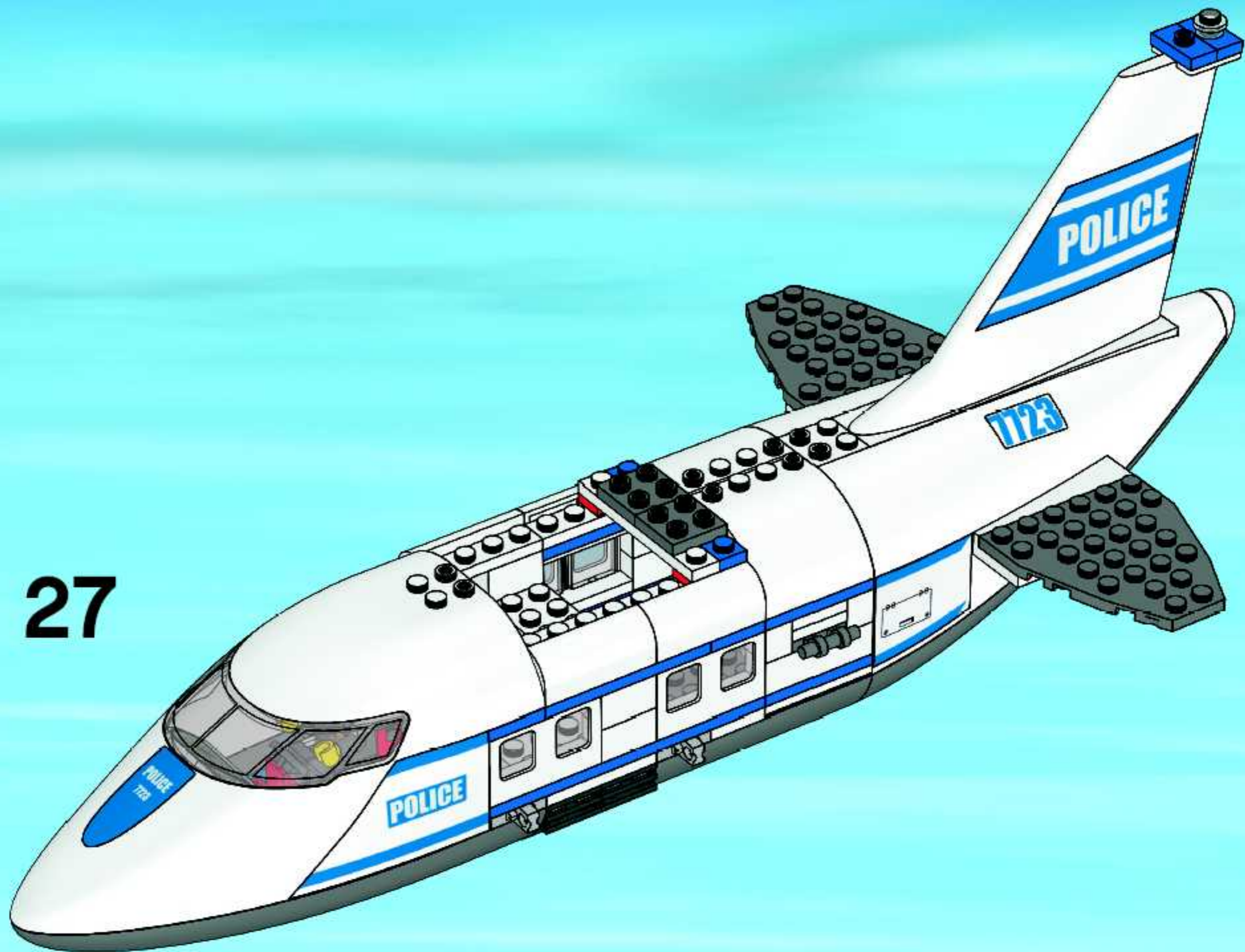

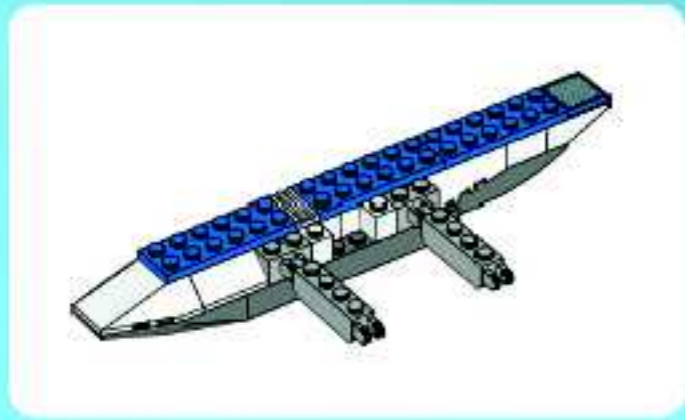
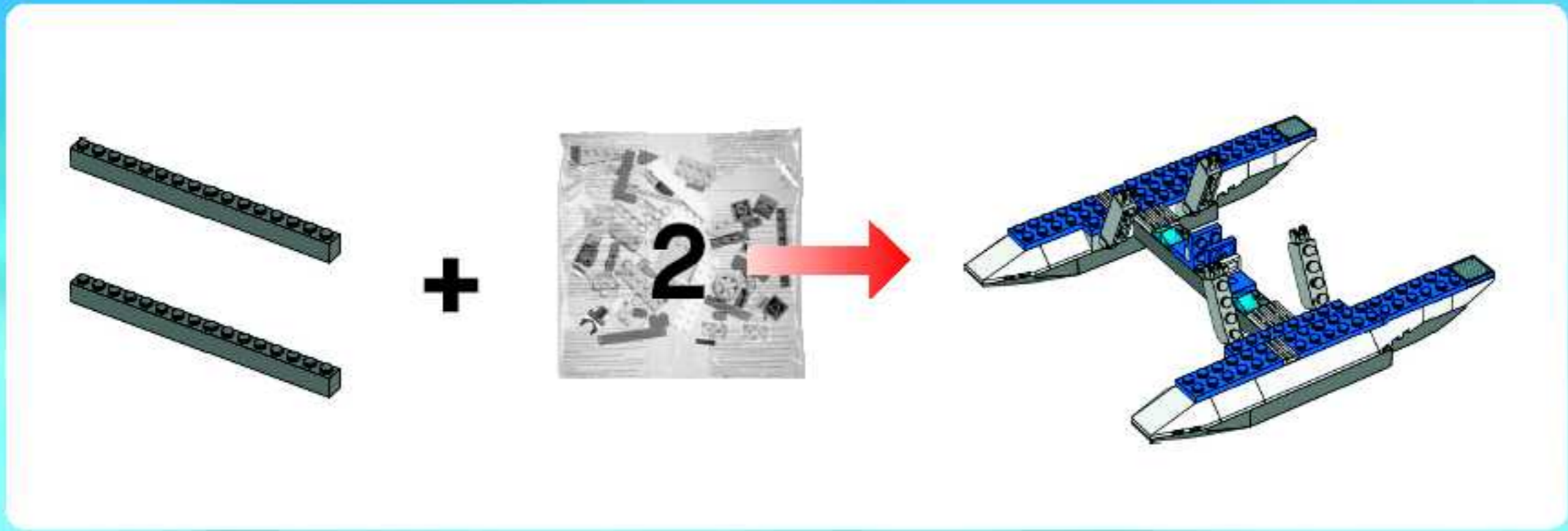

1

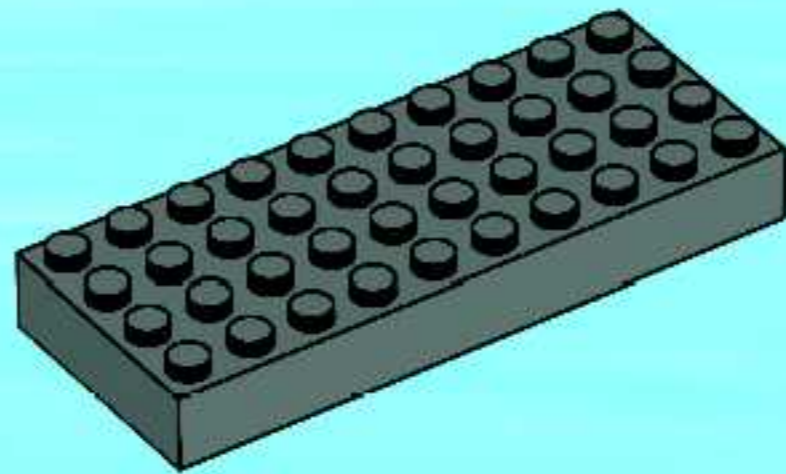

2

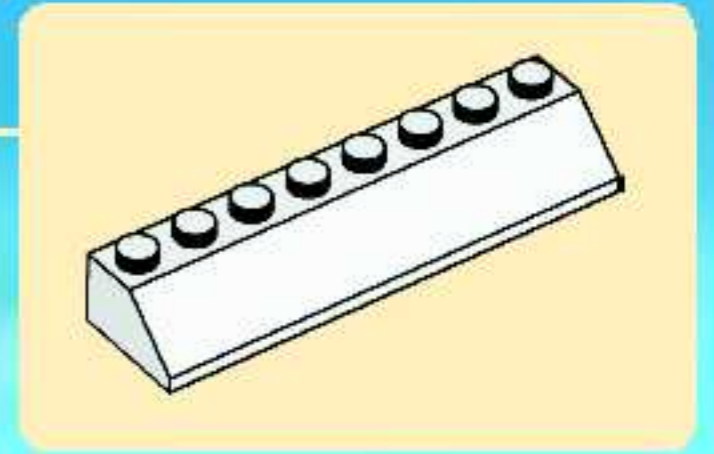
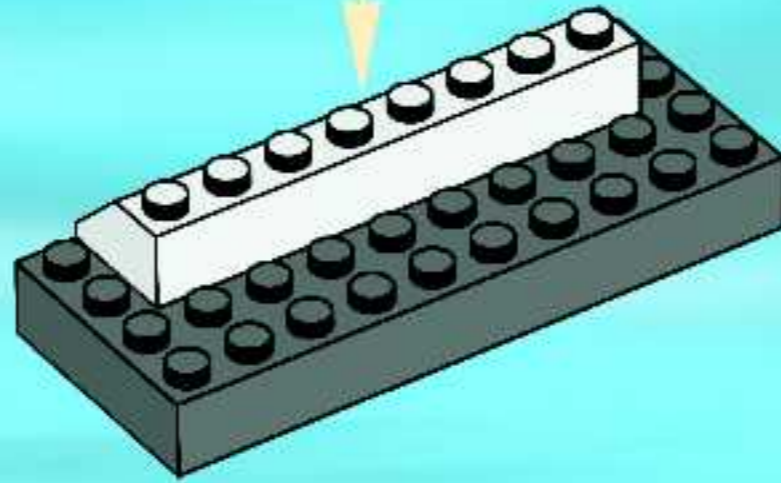

3

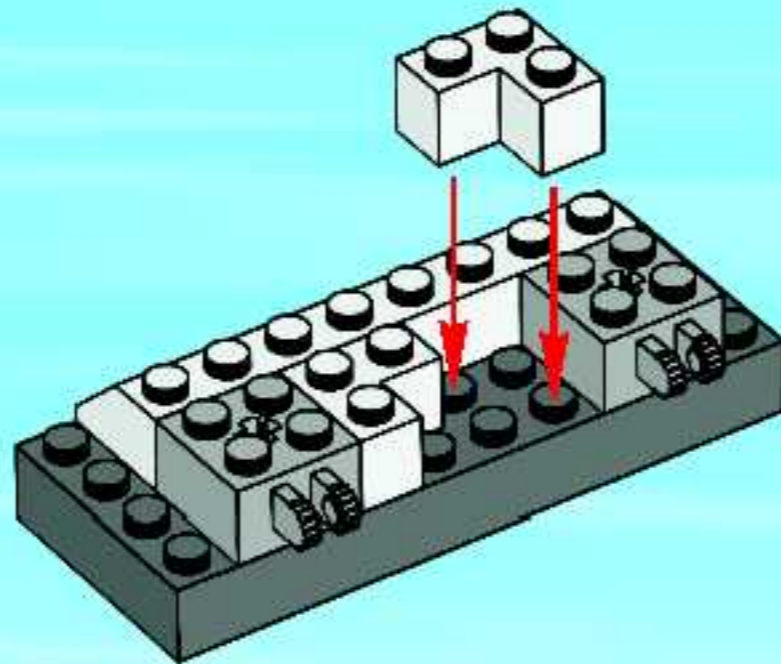

4

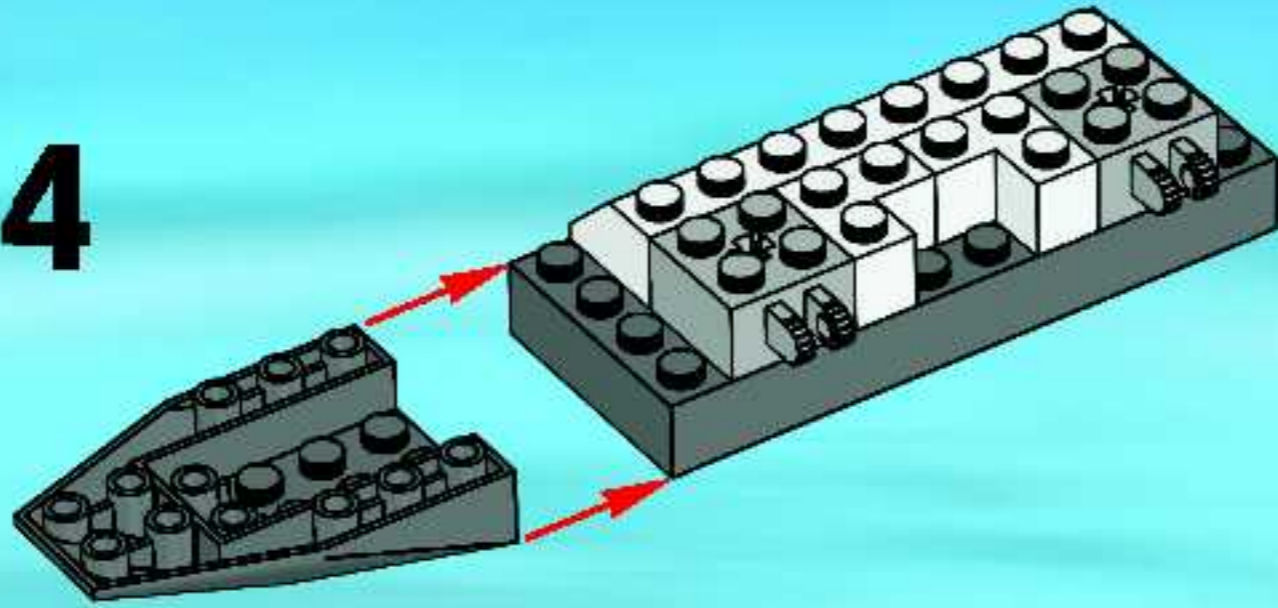

5

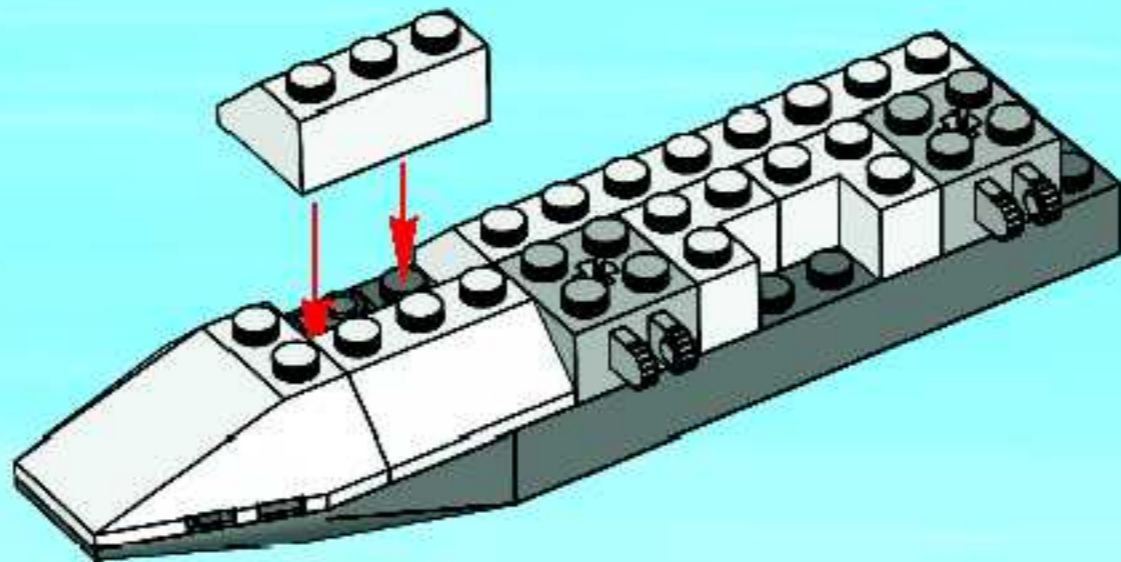

6

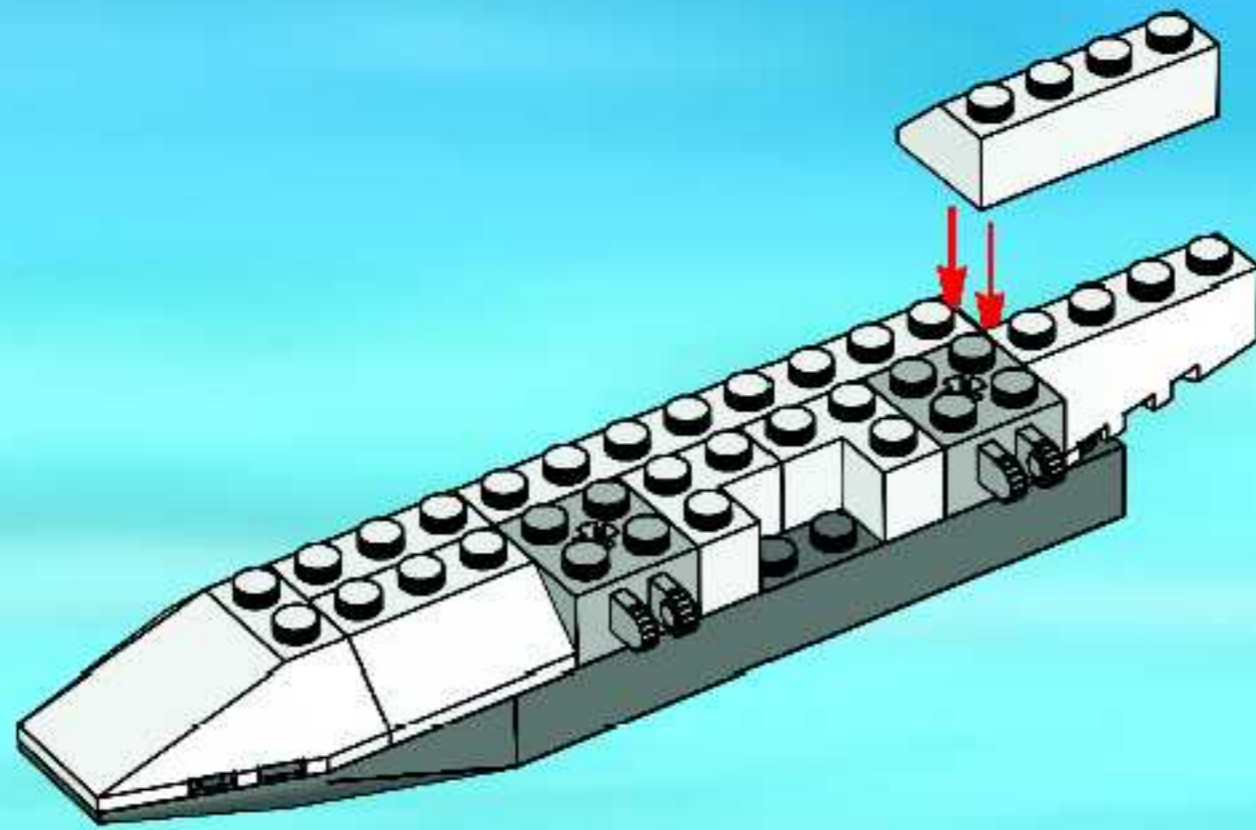

7

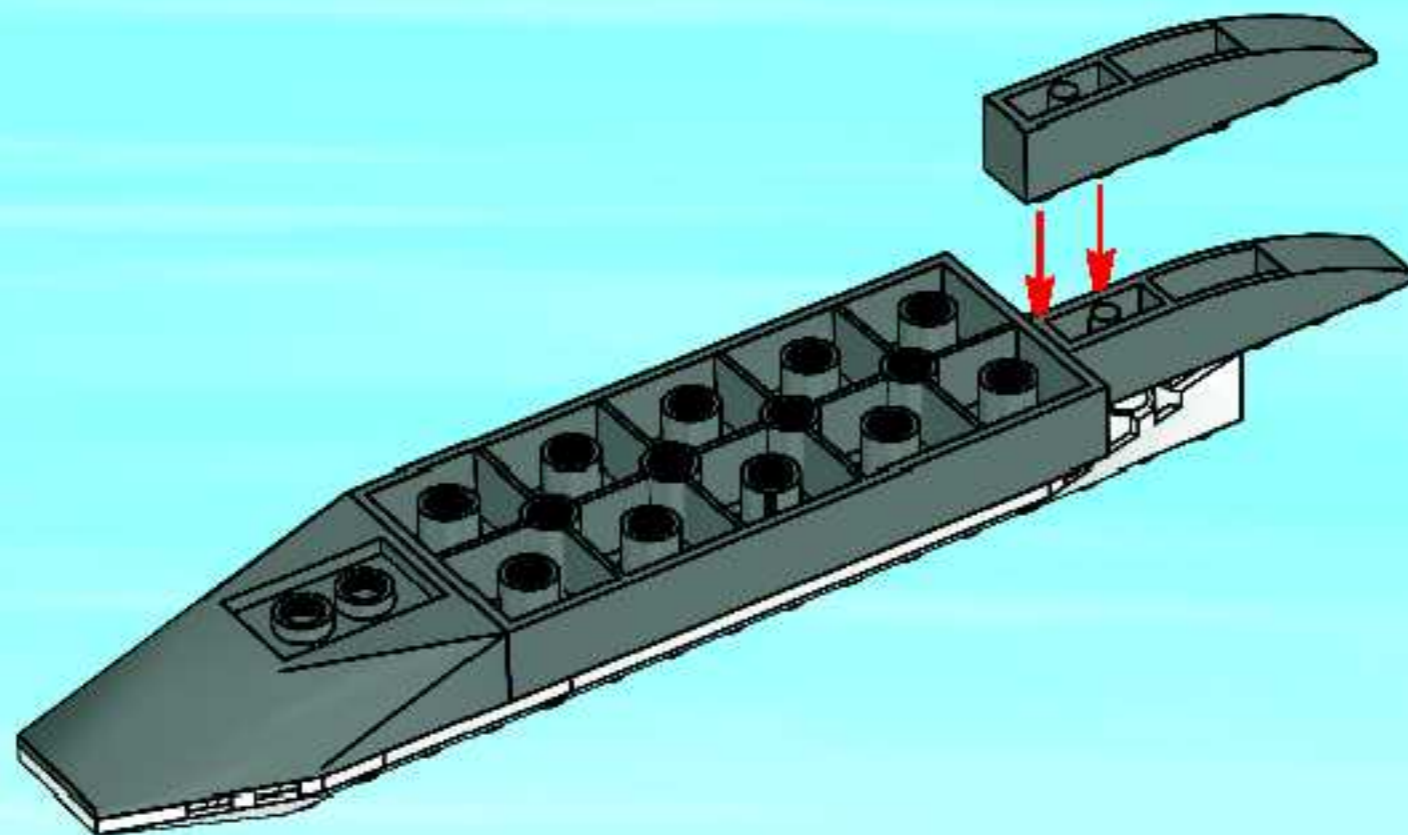

8

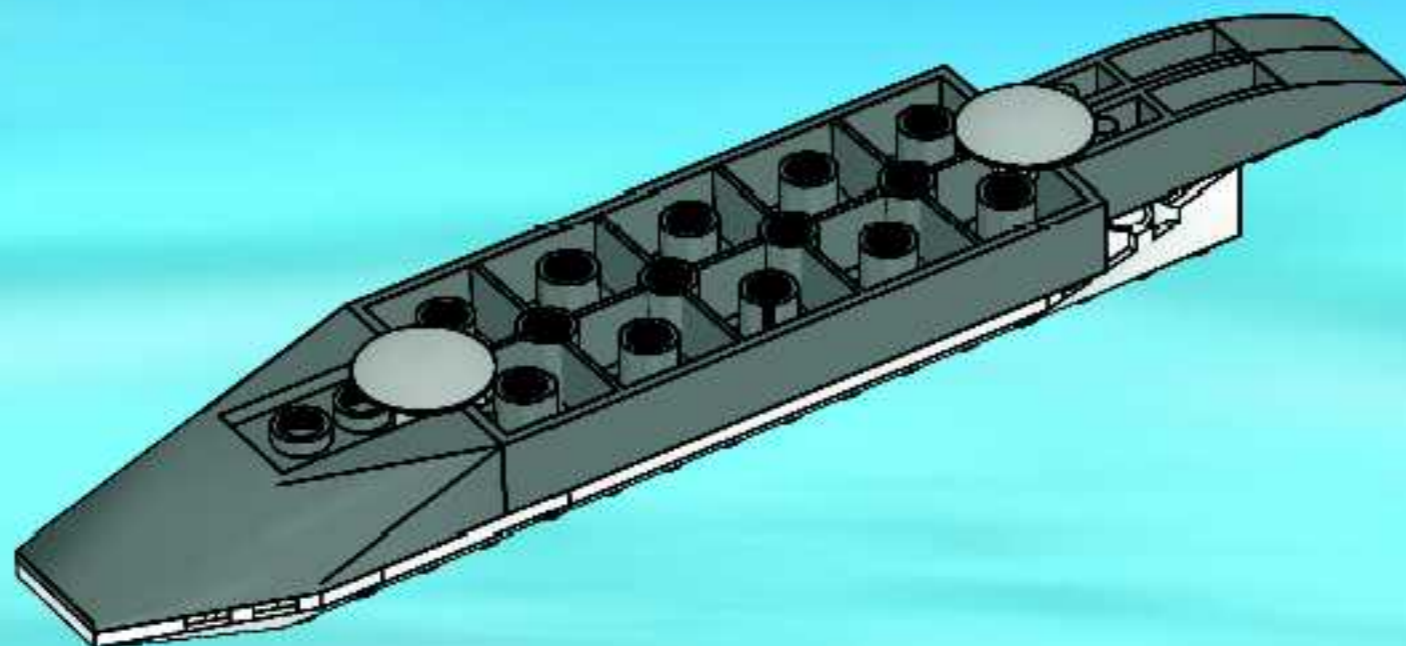

9

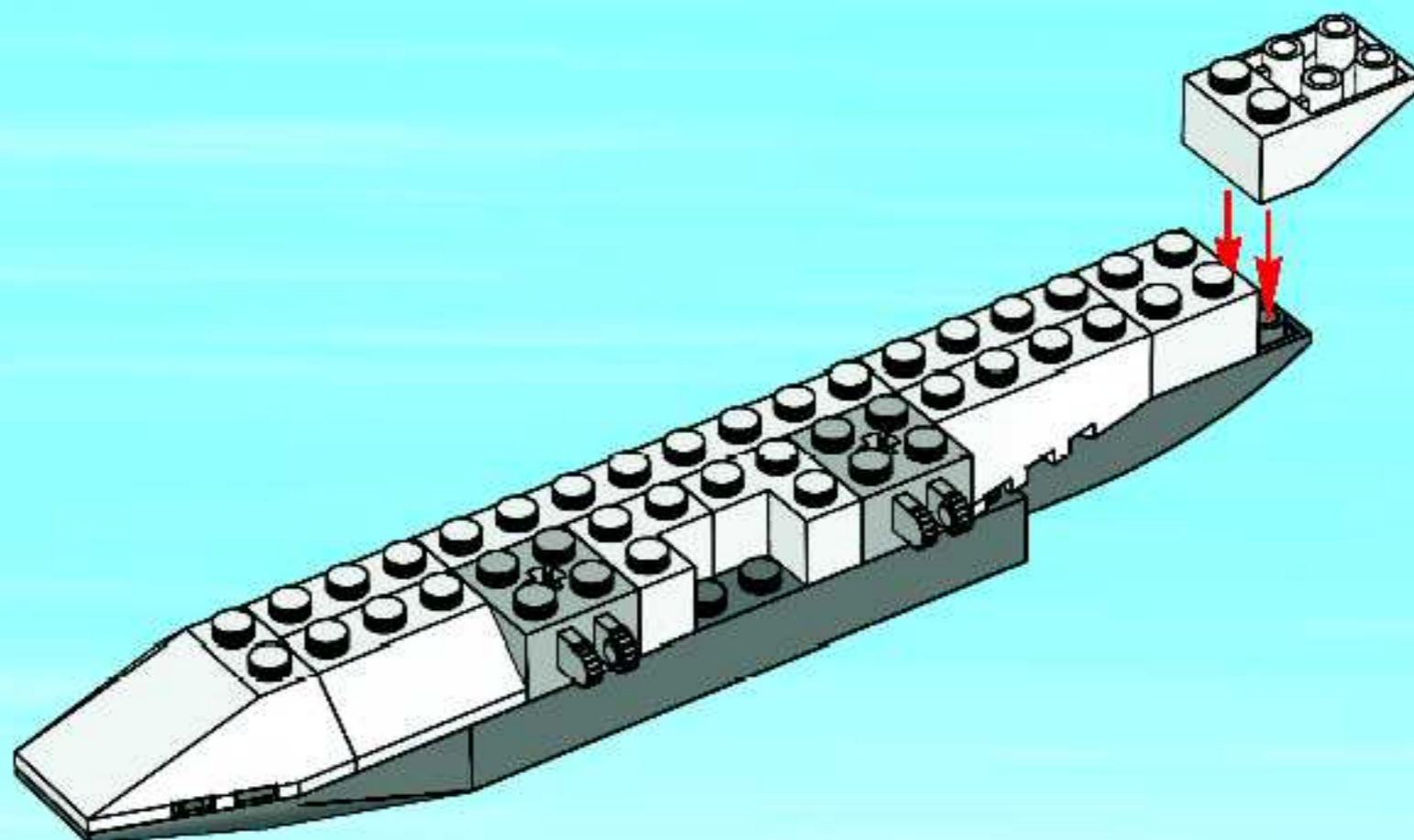

10

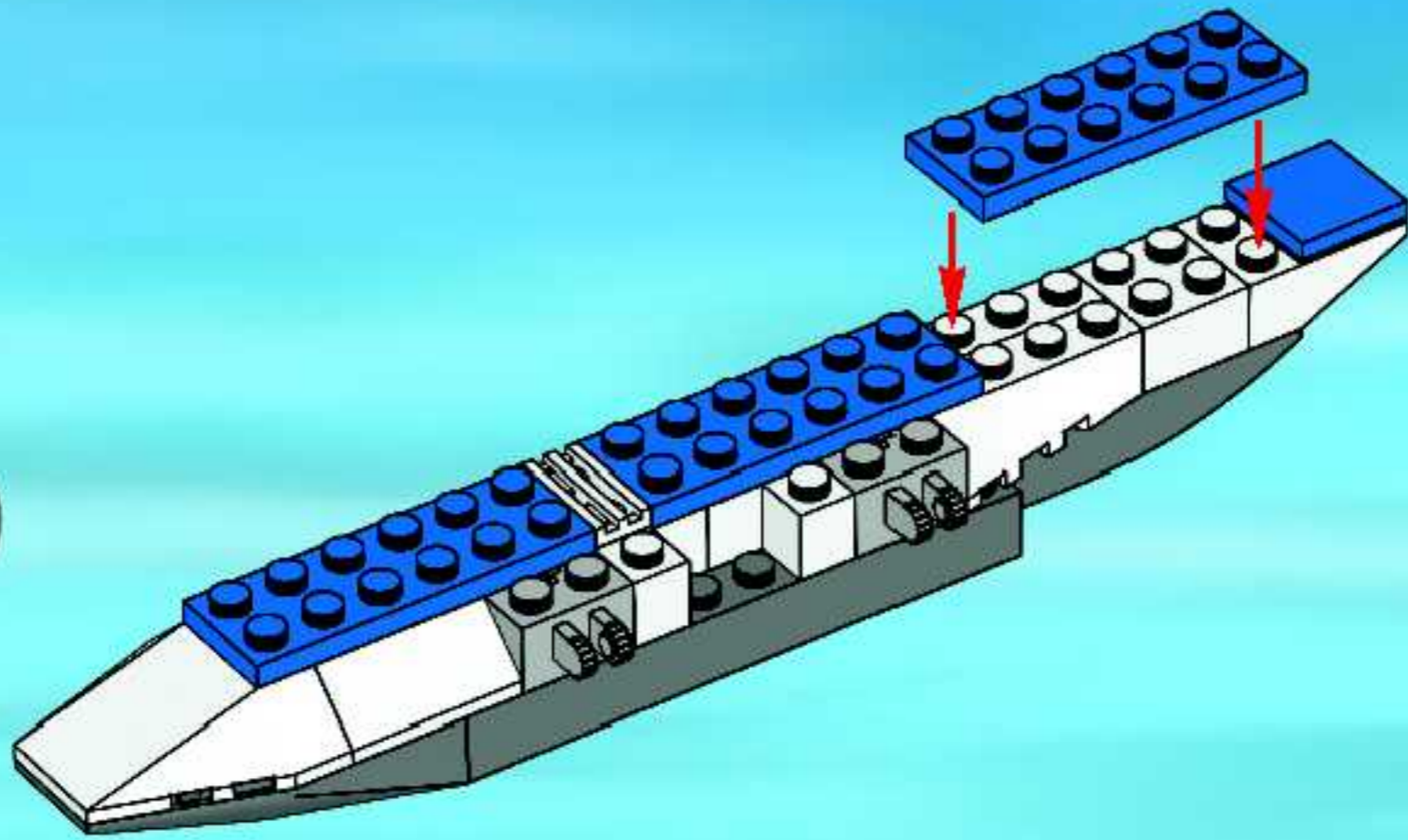

11

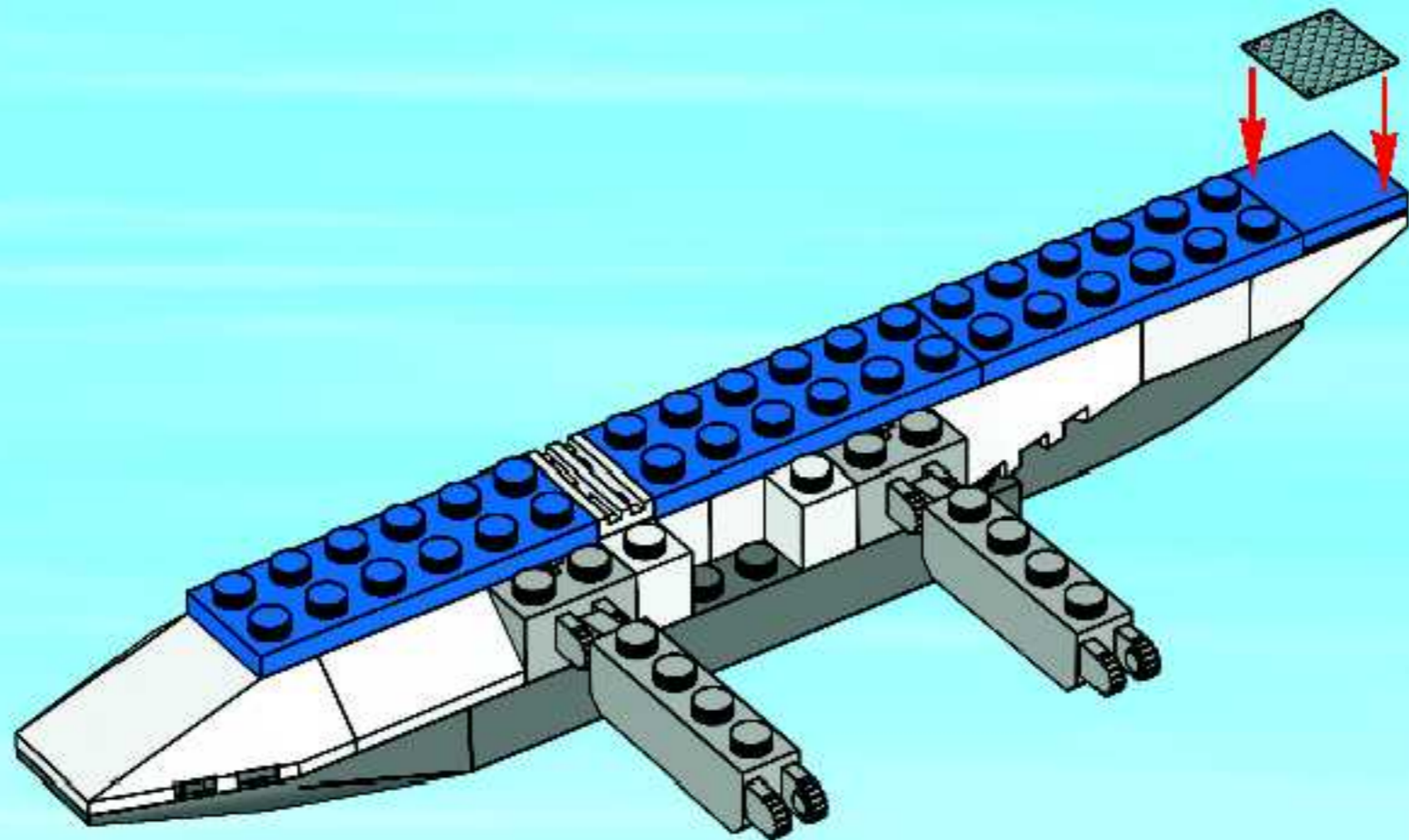

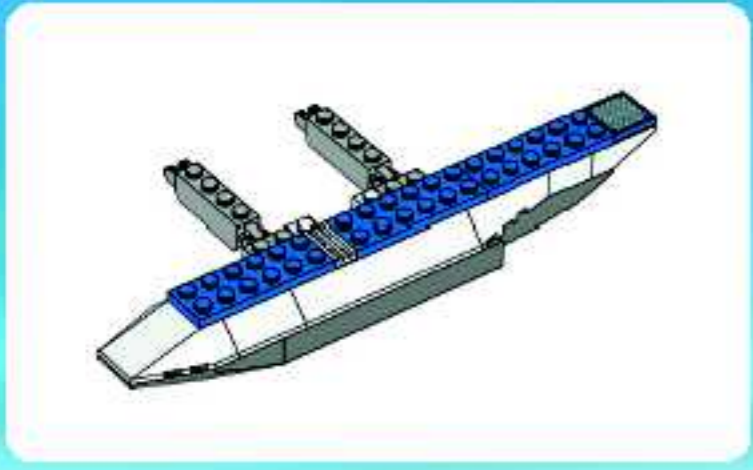

1

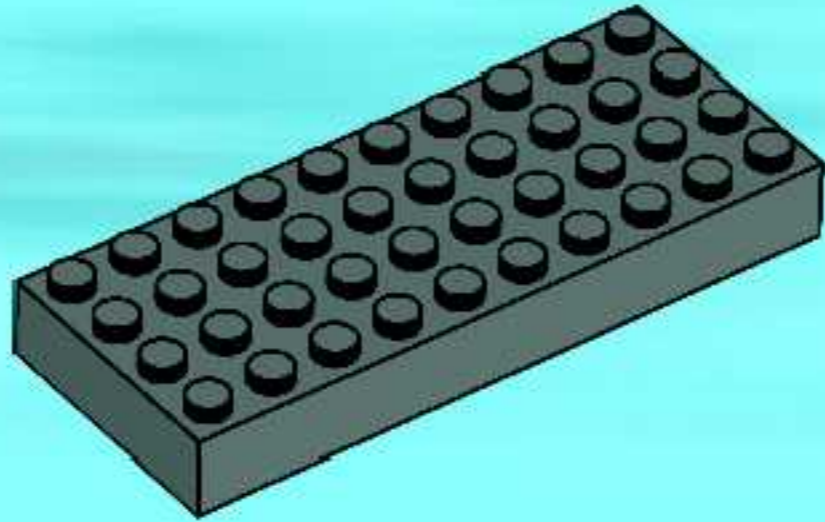

2

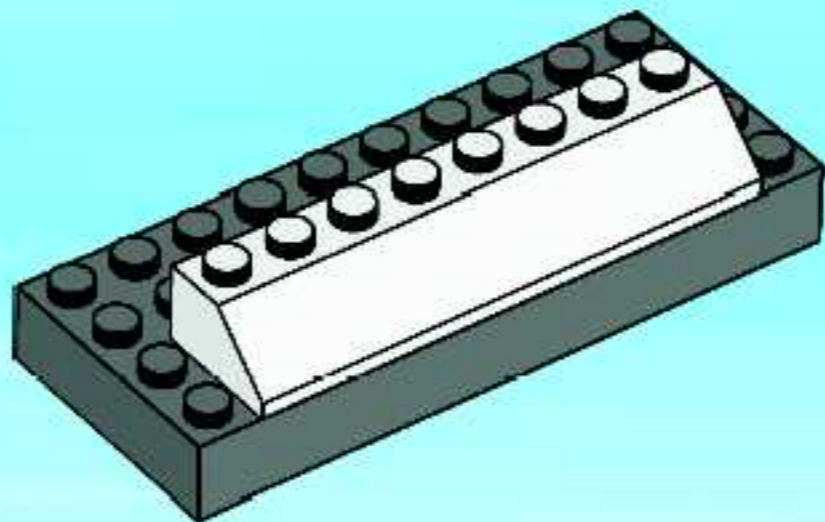

3

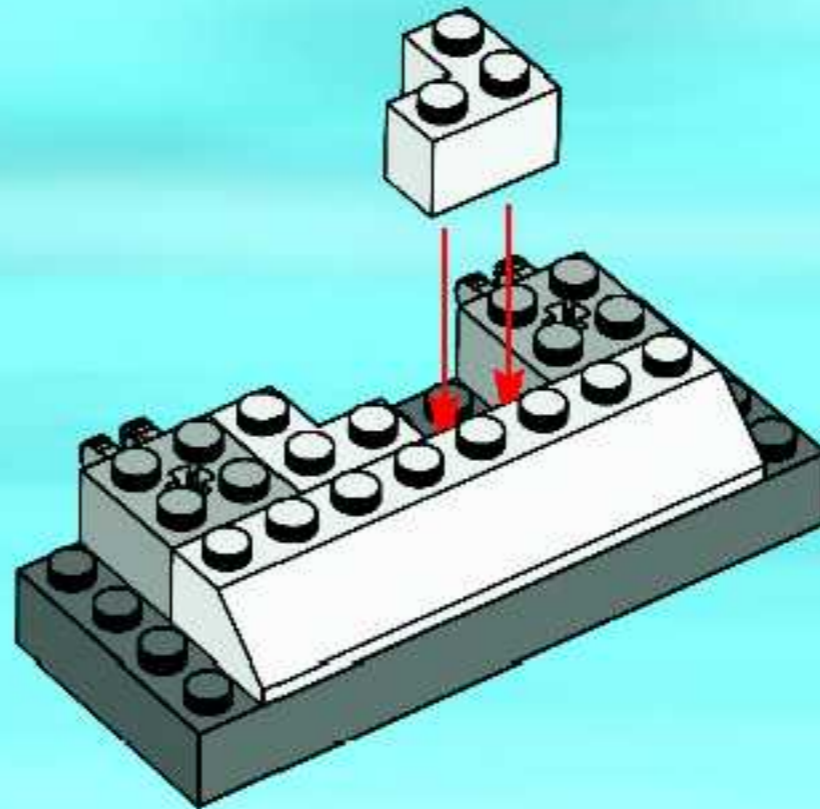

4

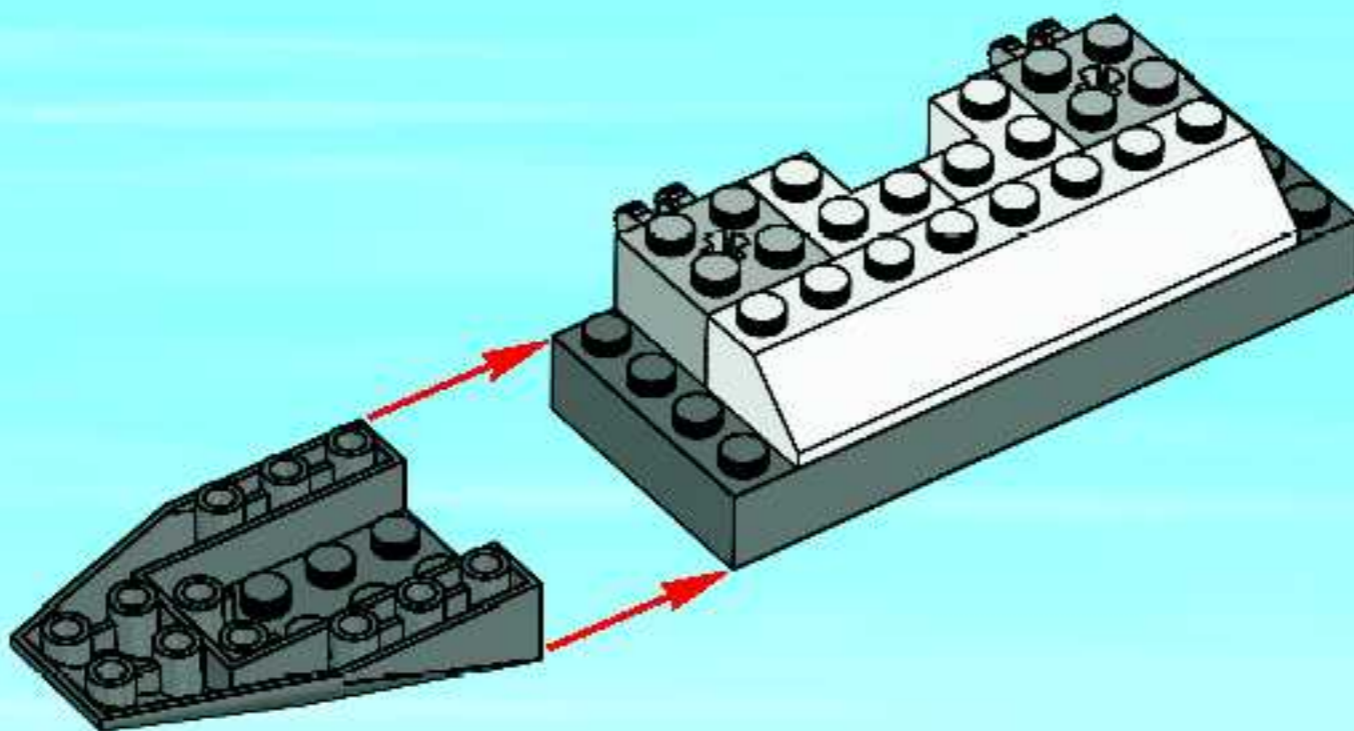

5

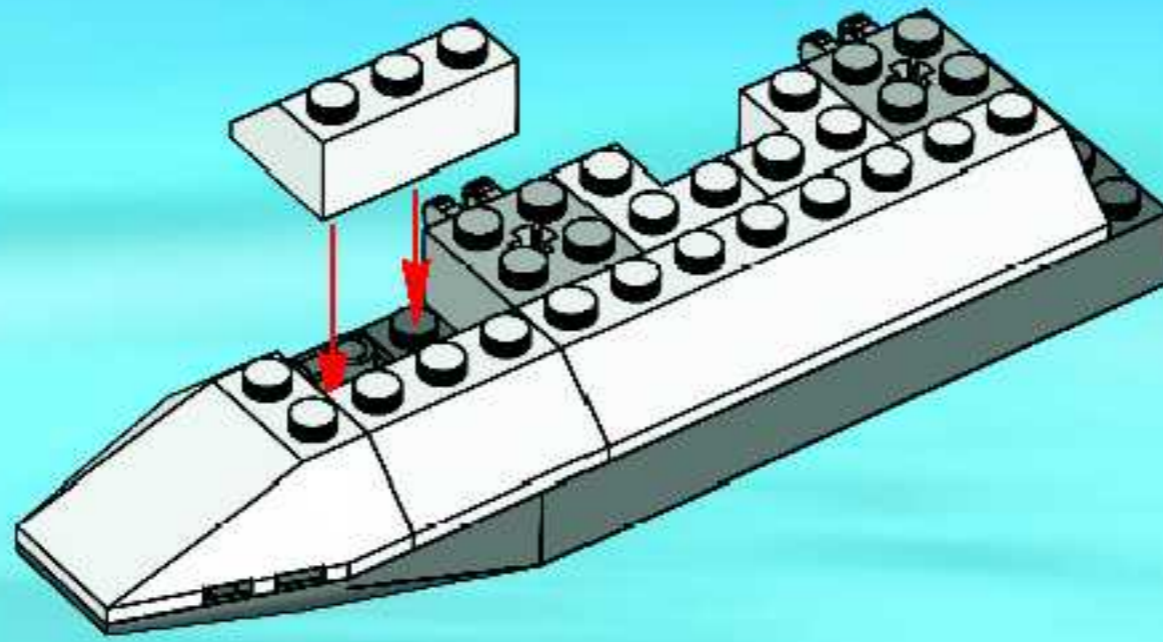

6

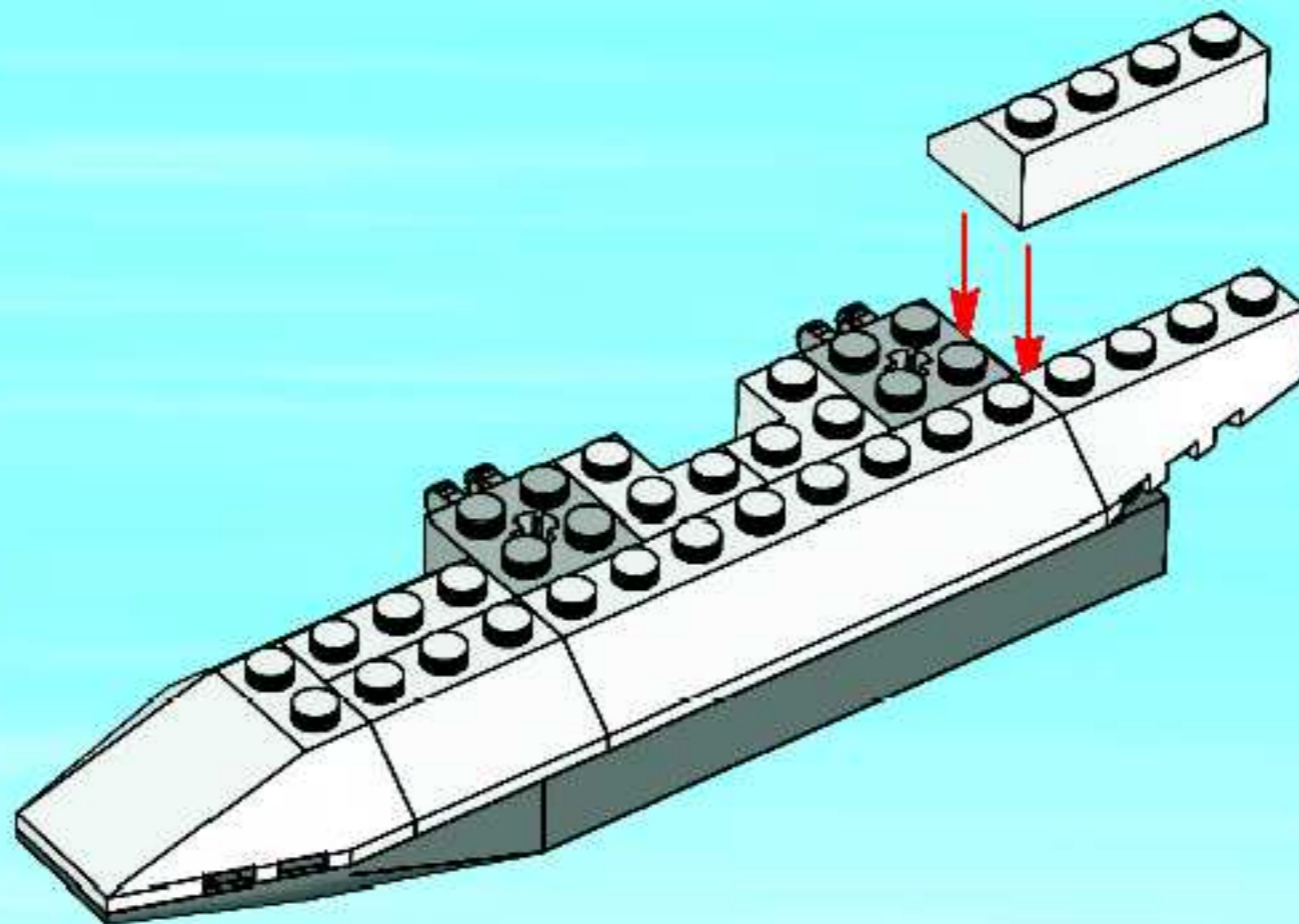

7

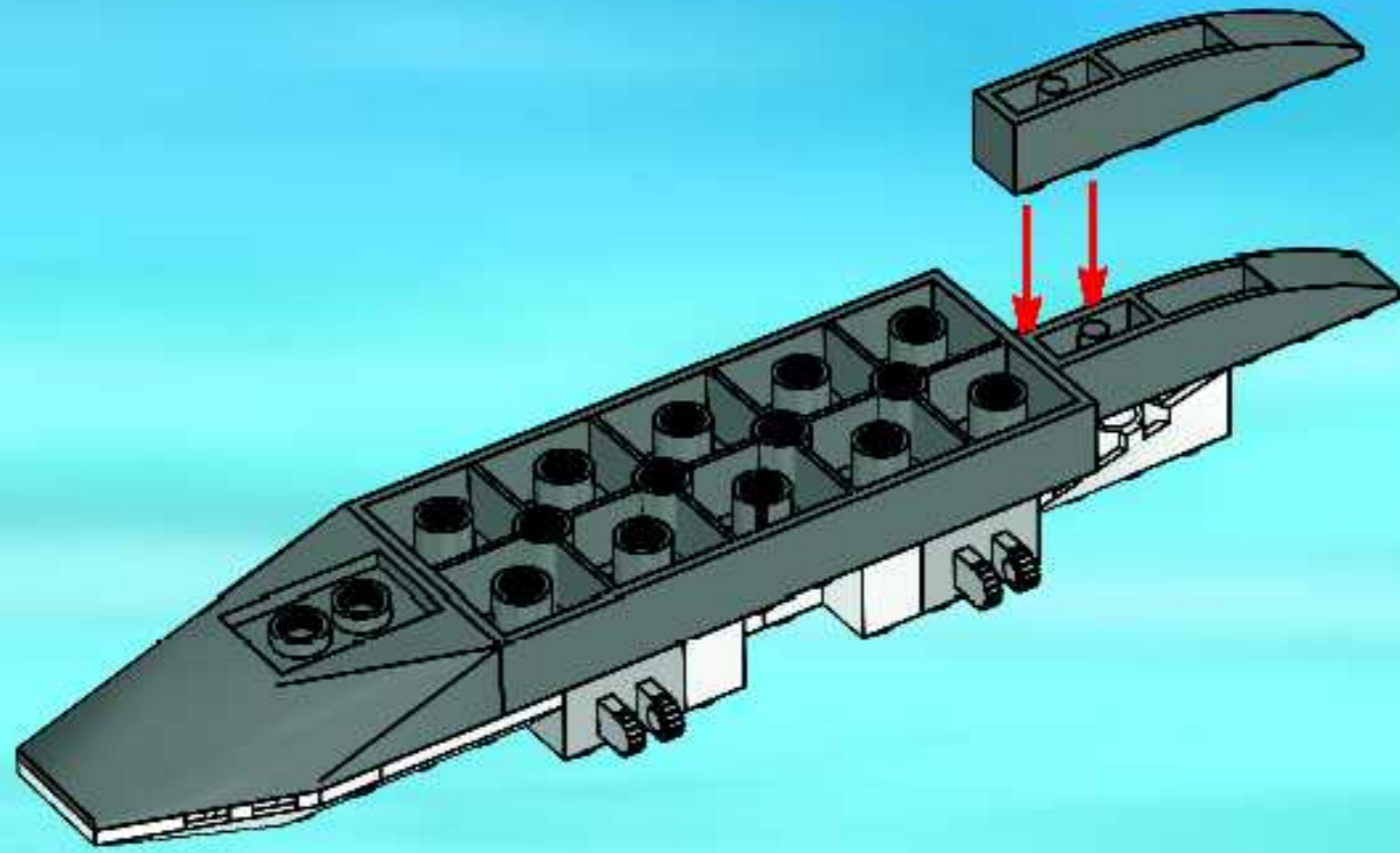

8

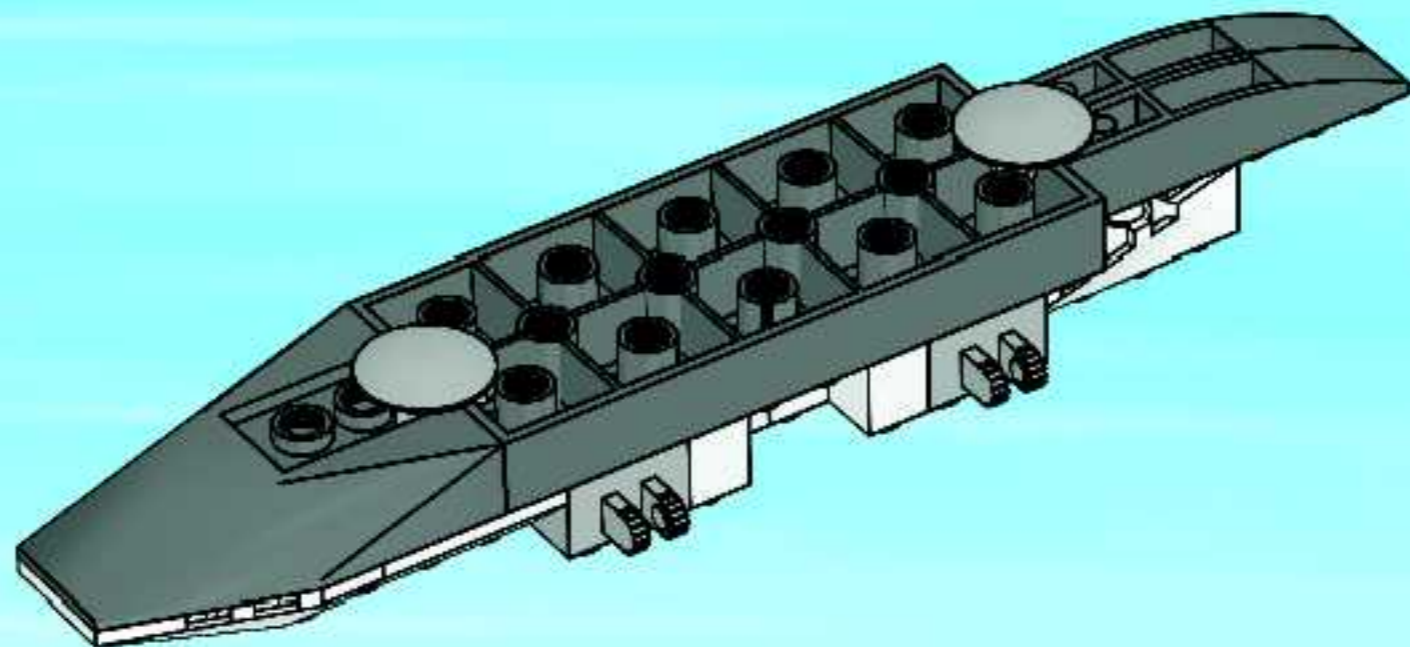

9

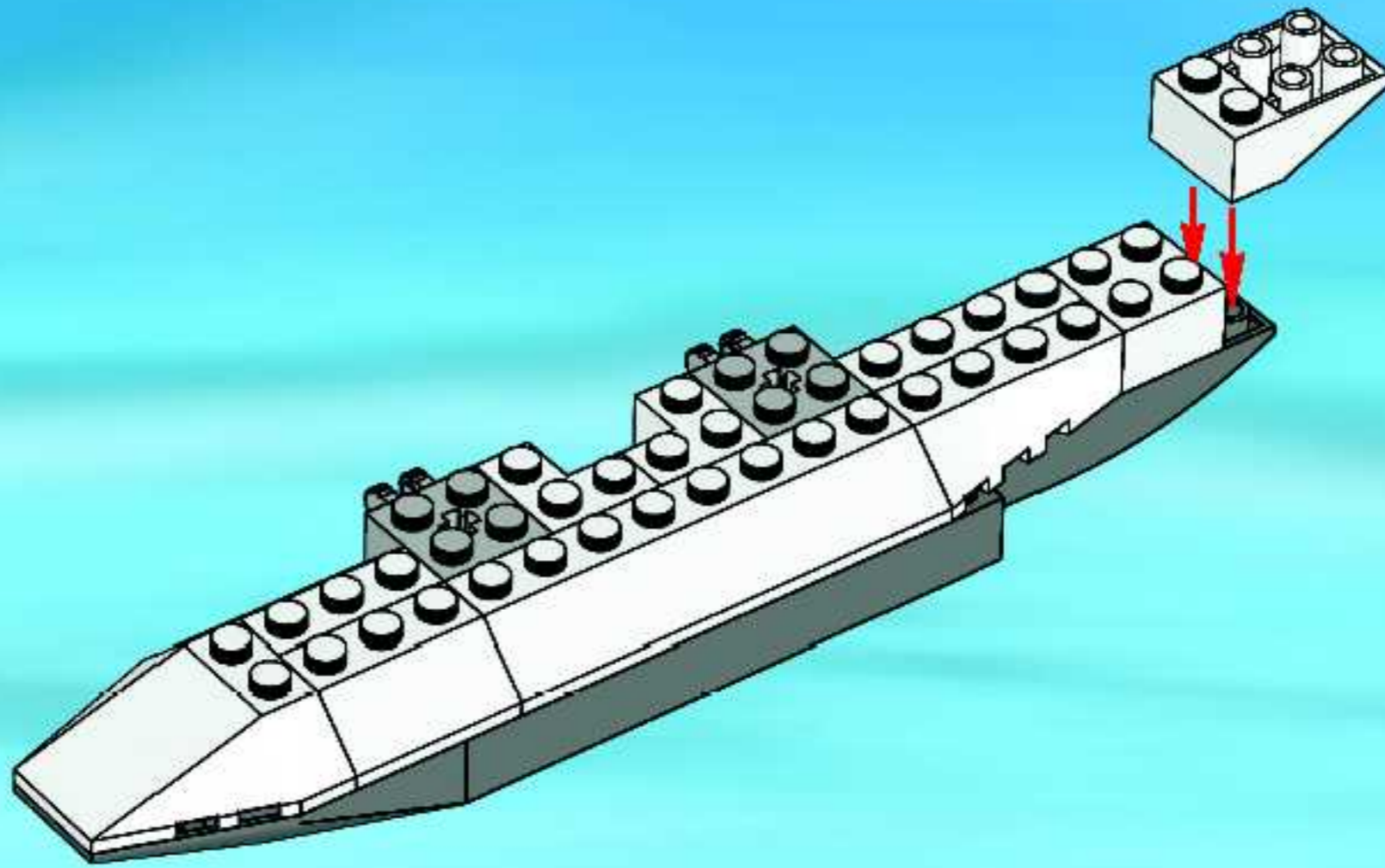

10

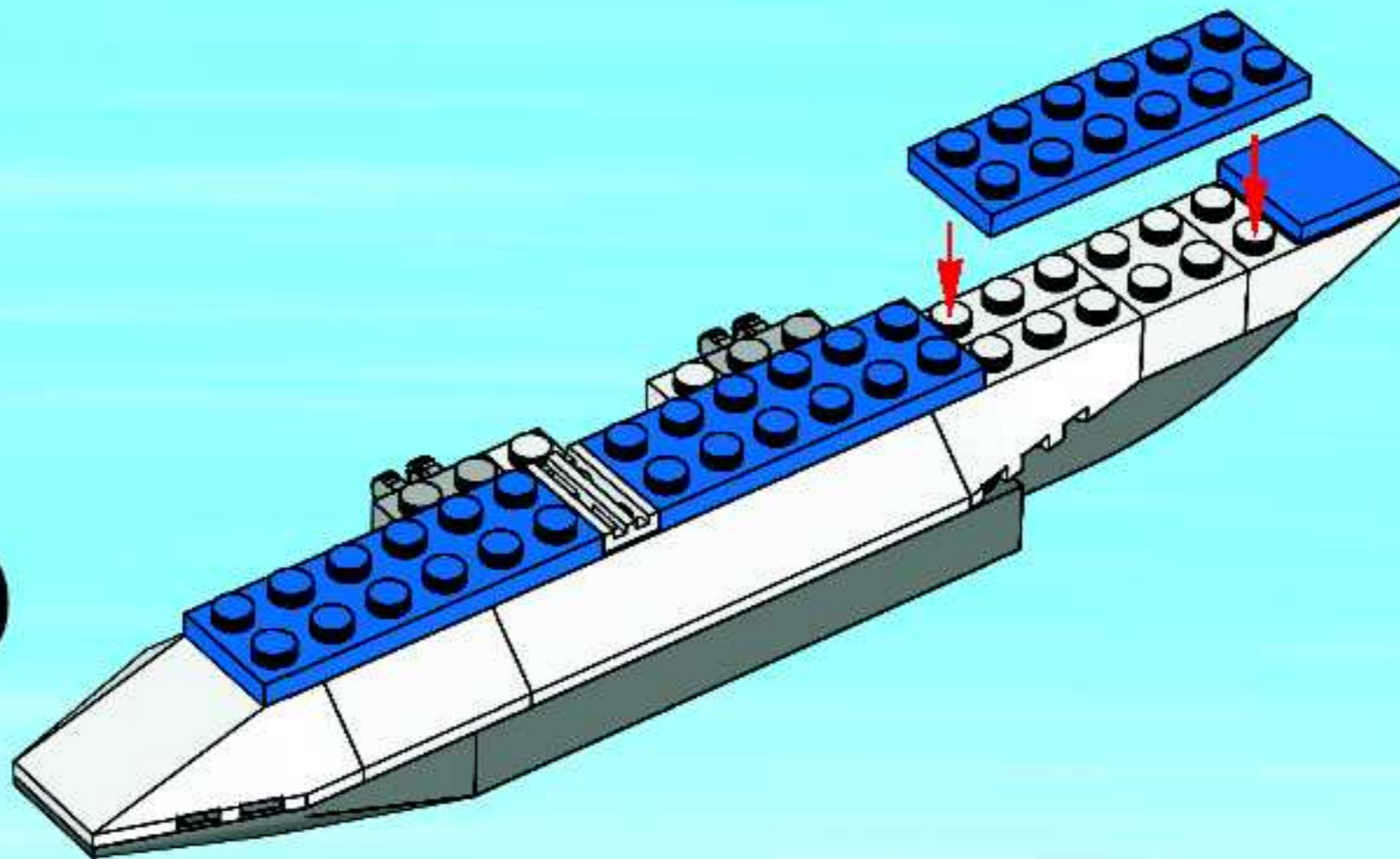

11

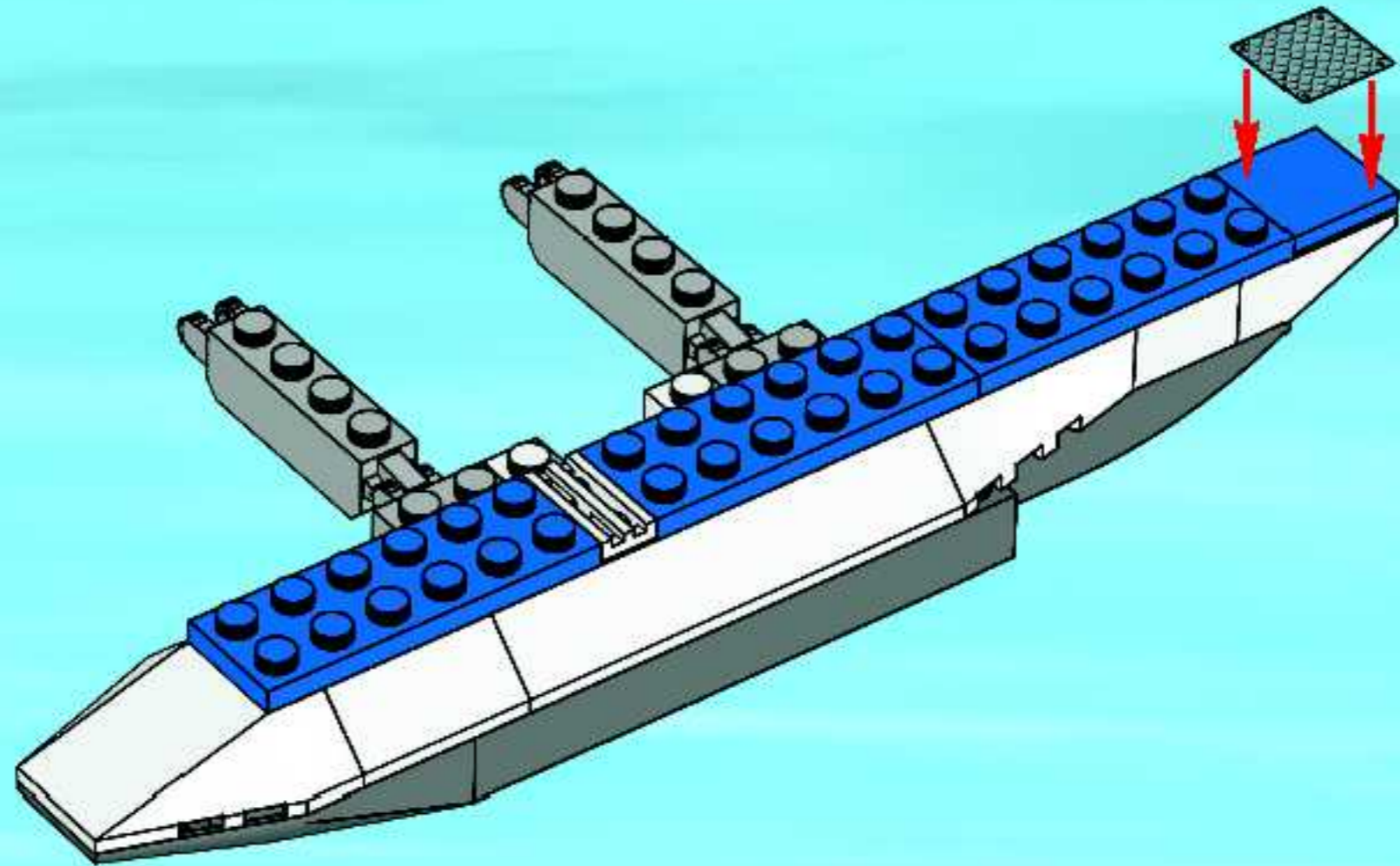

12

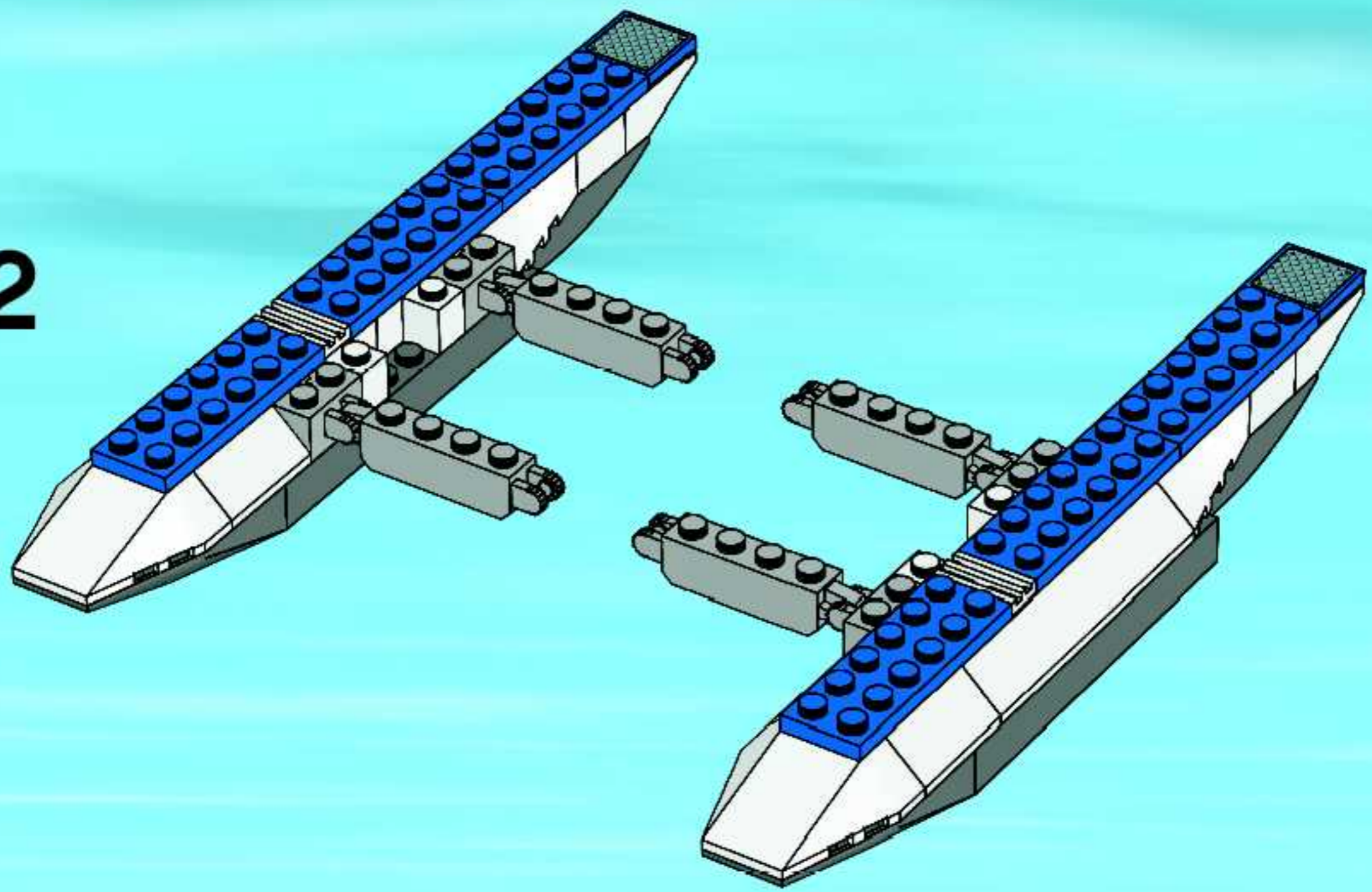

13

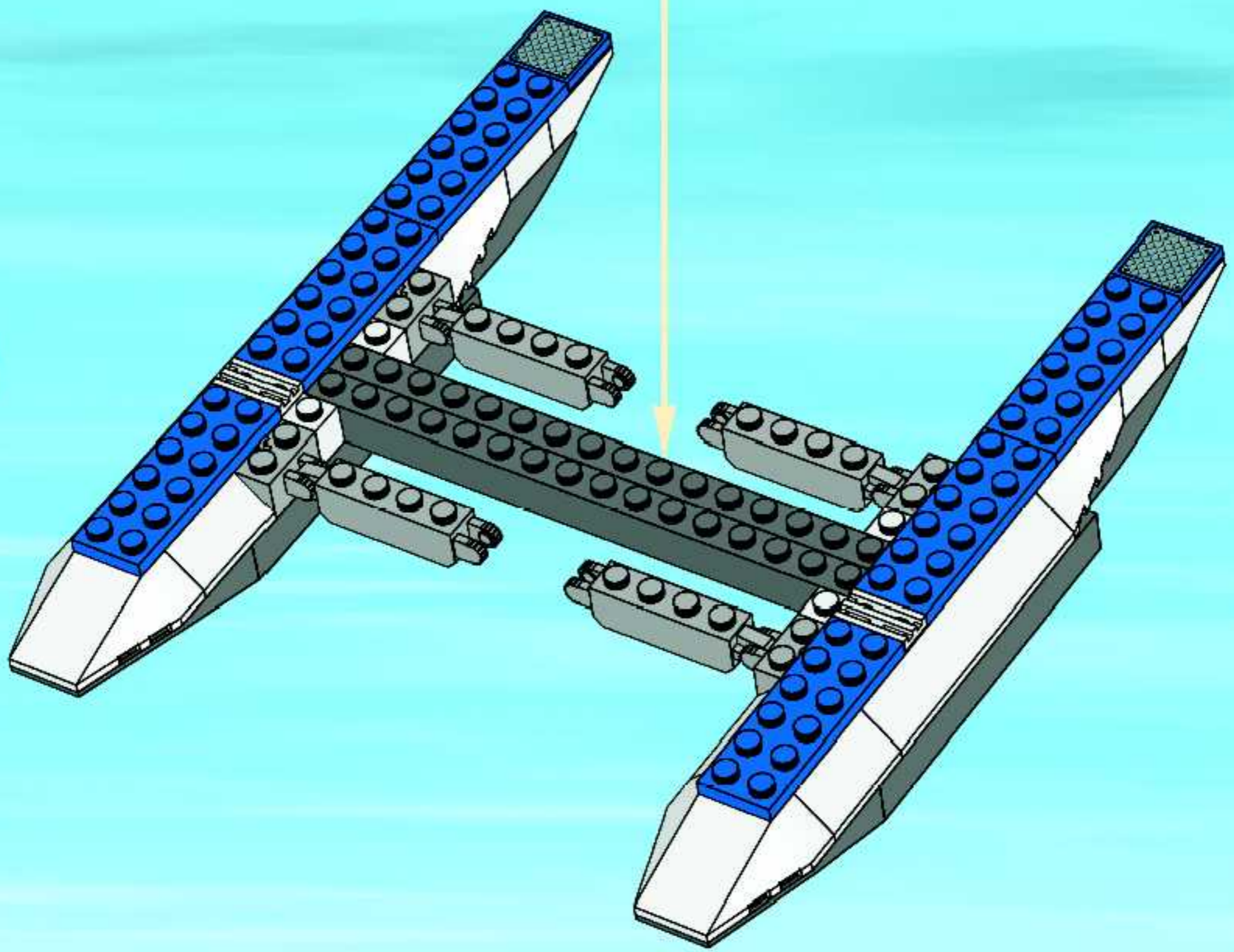
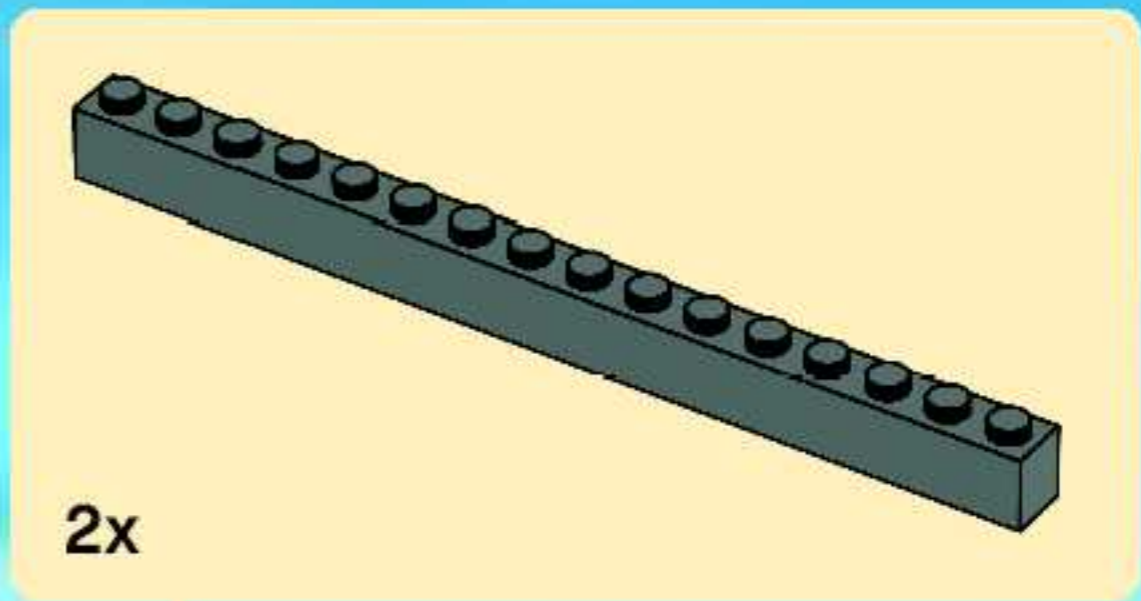

14

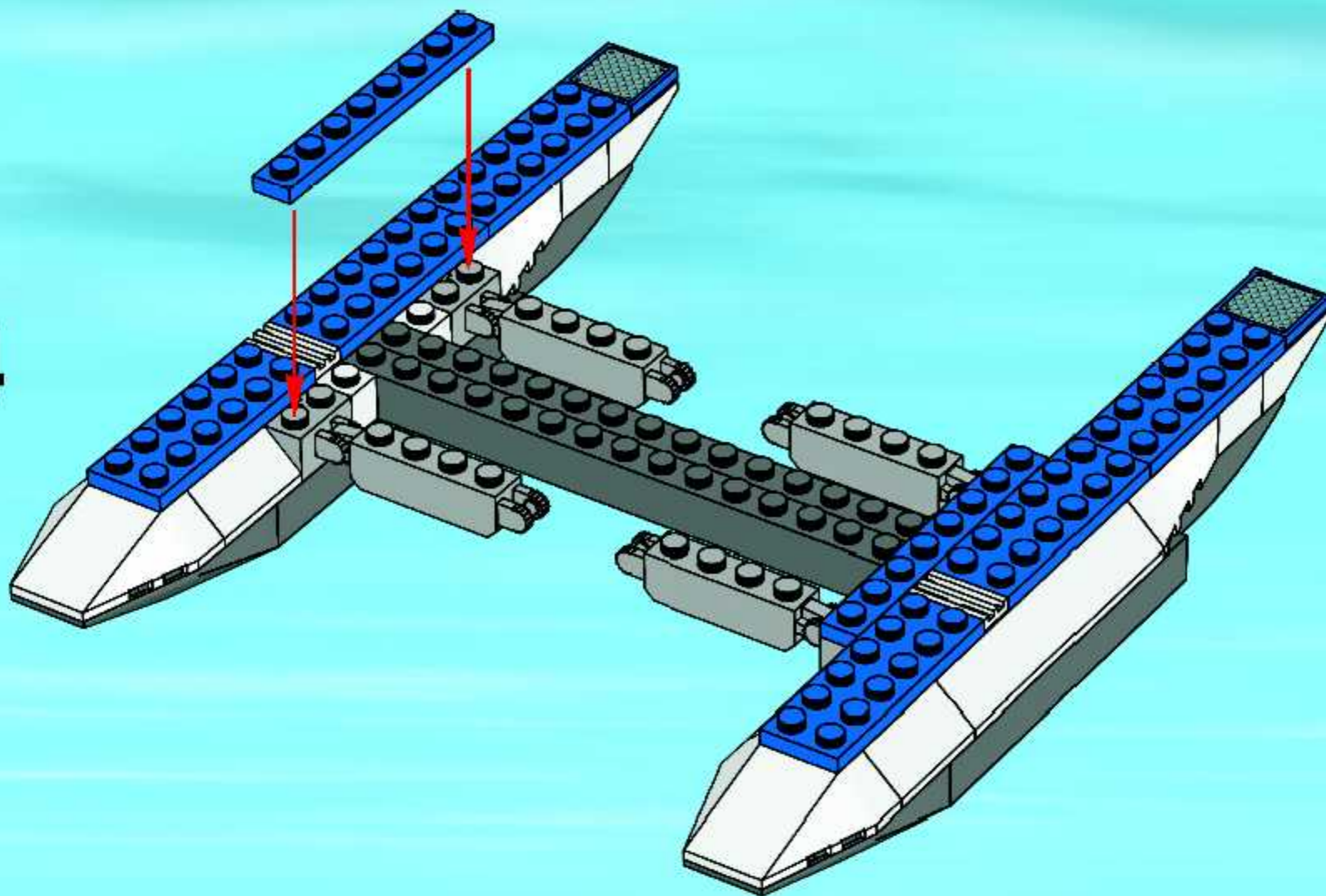

15

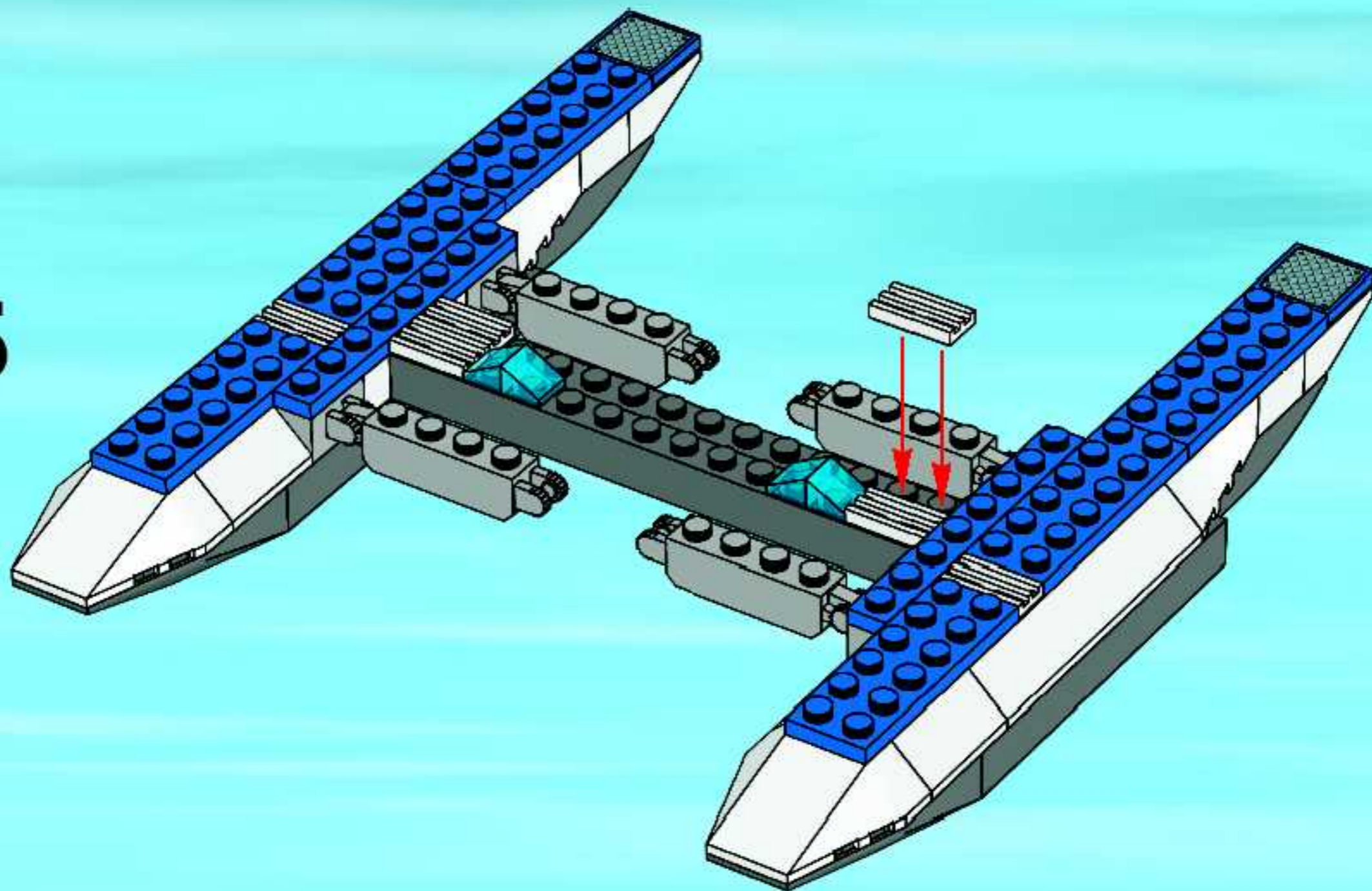

16

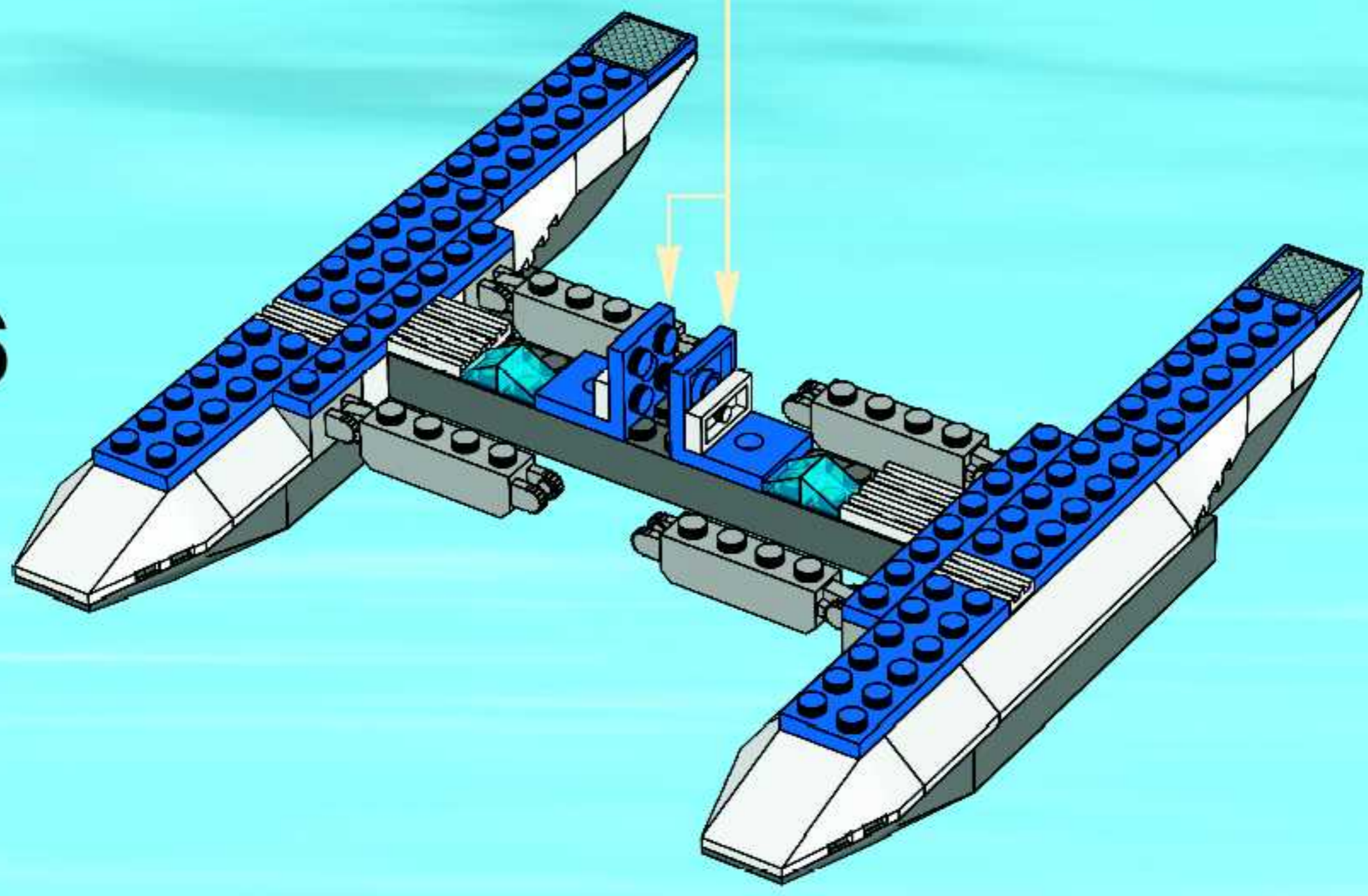
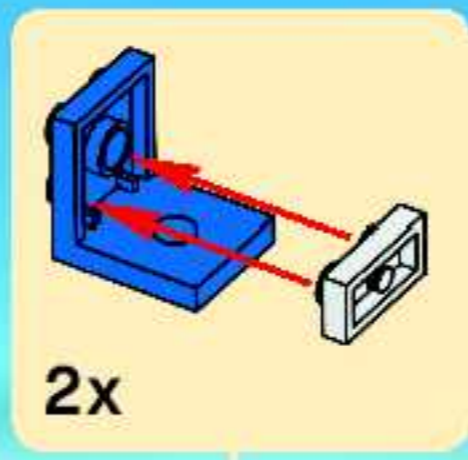

17

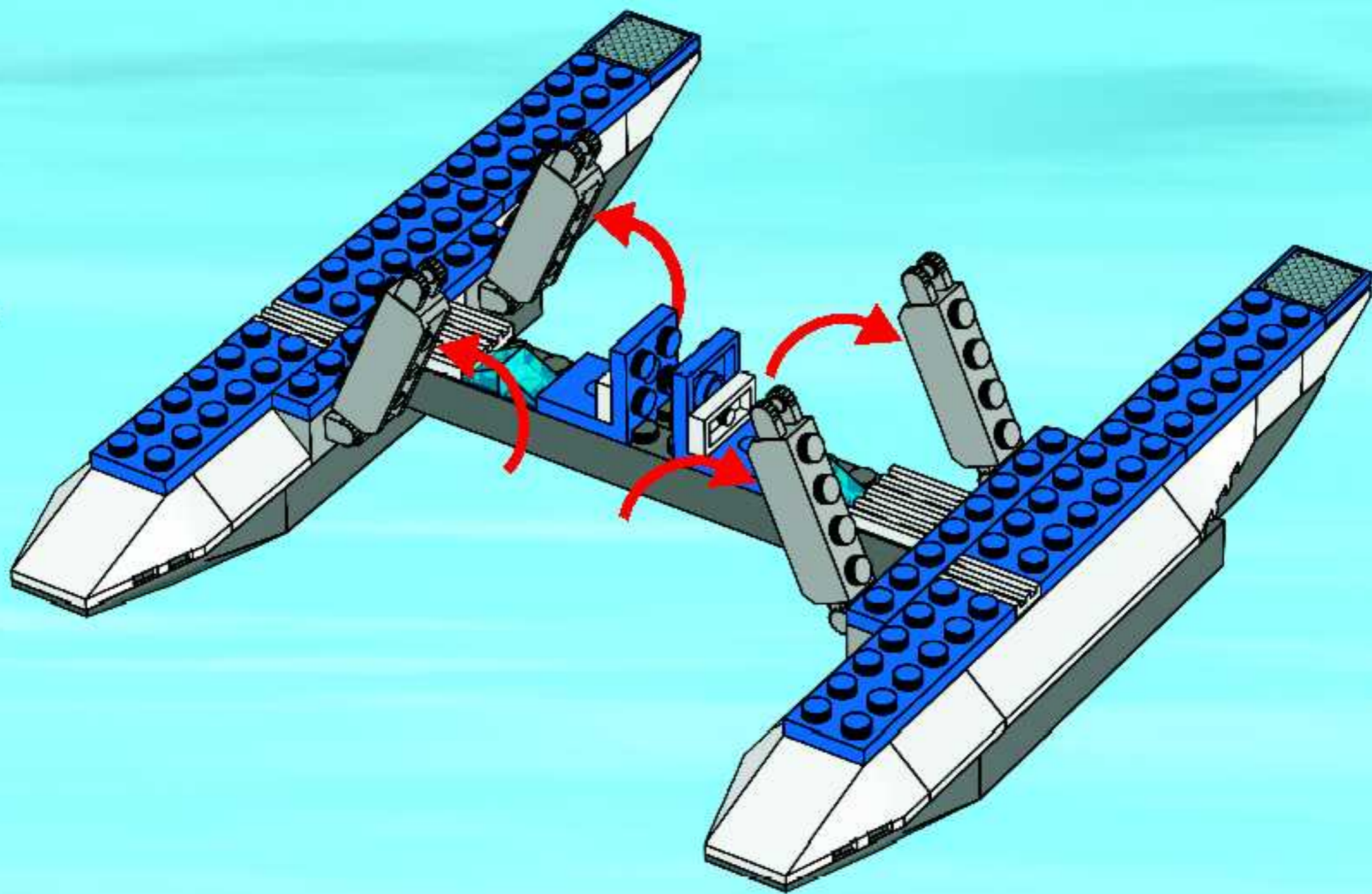



18

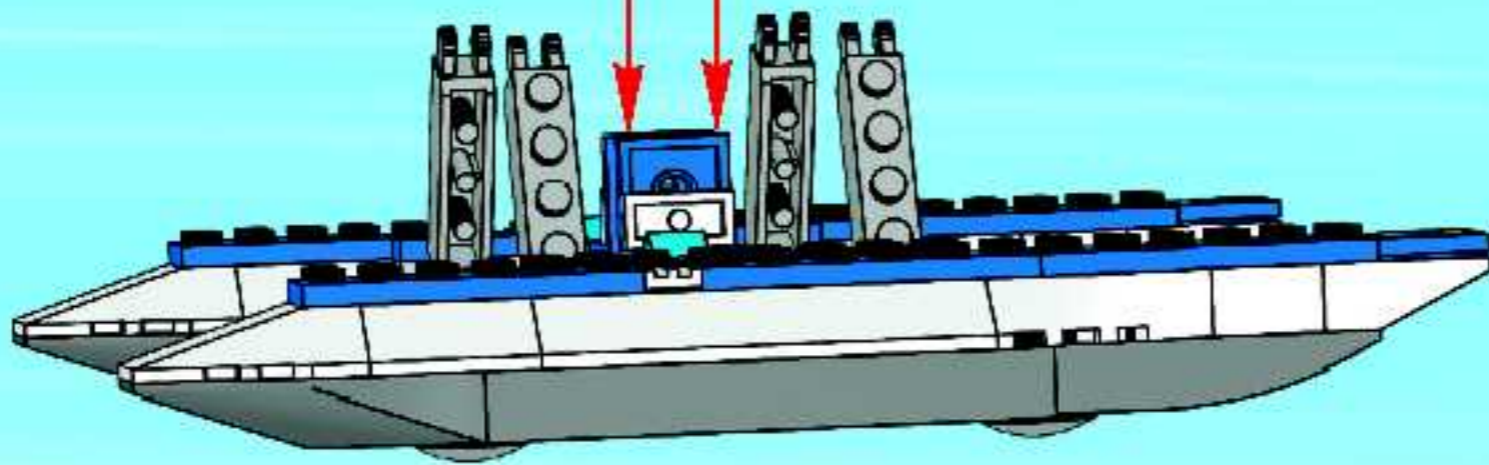

19

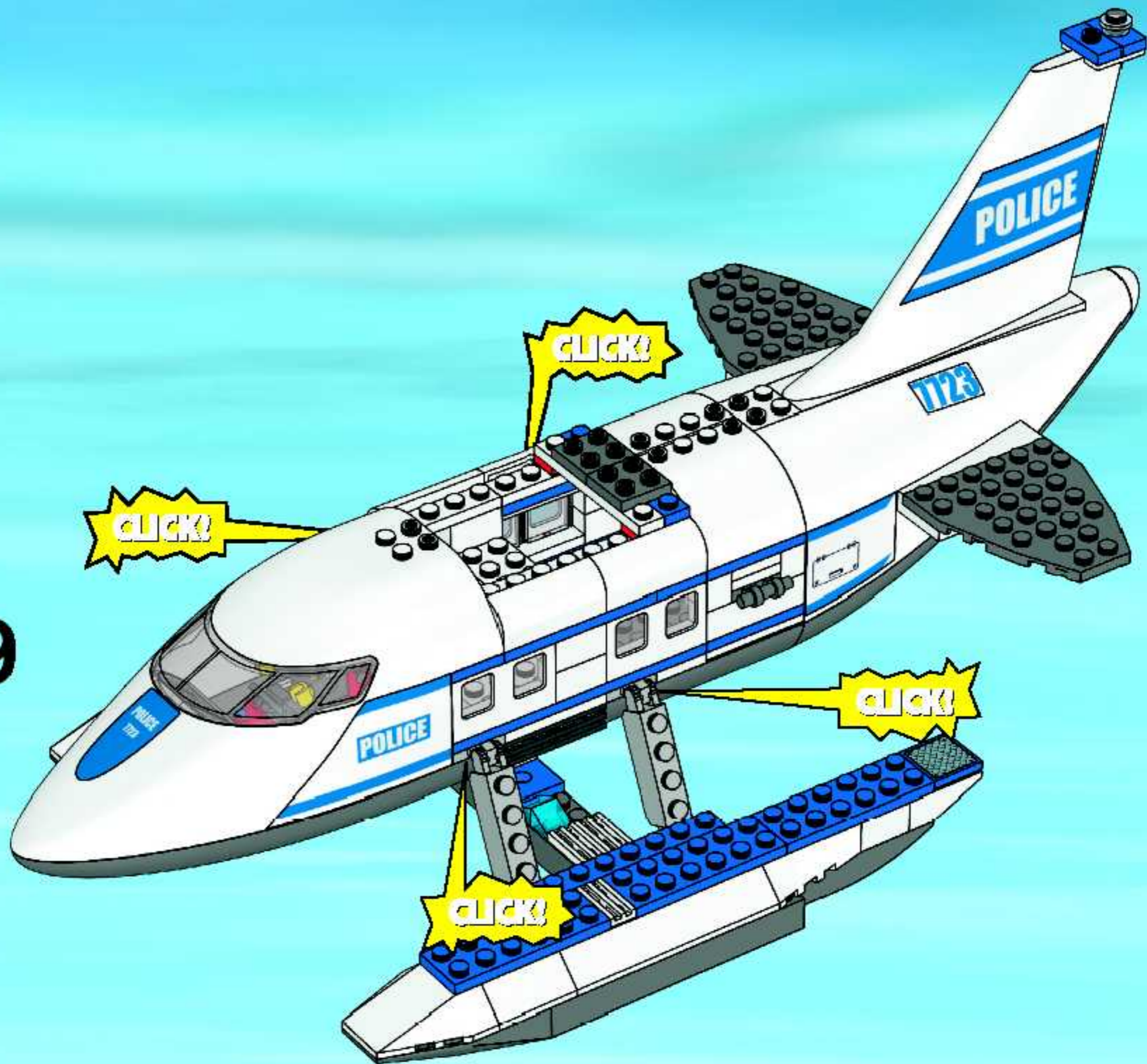

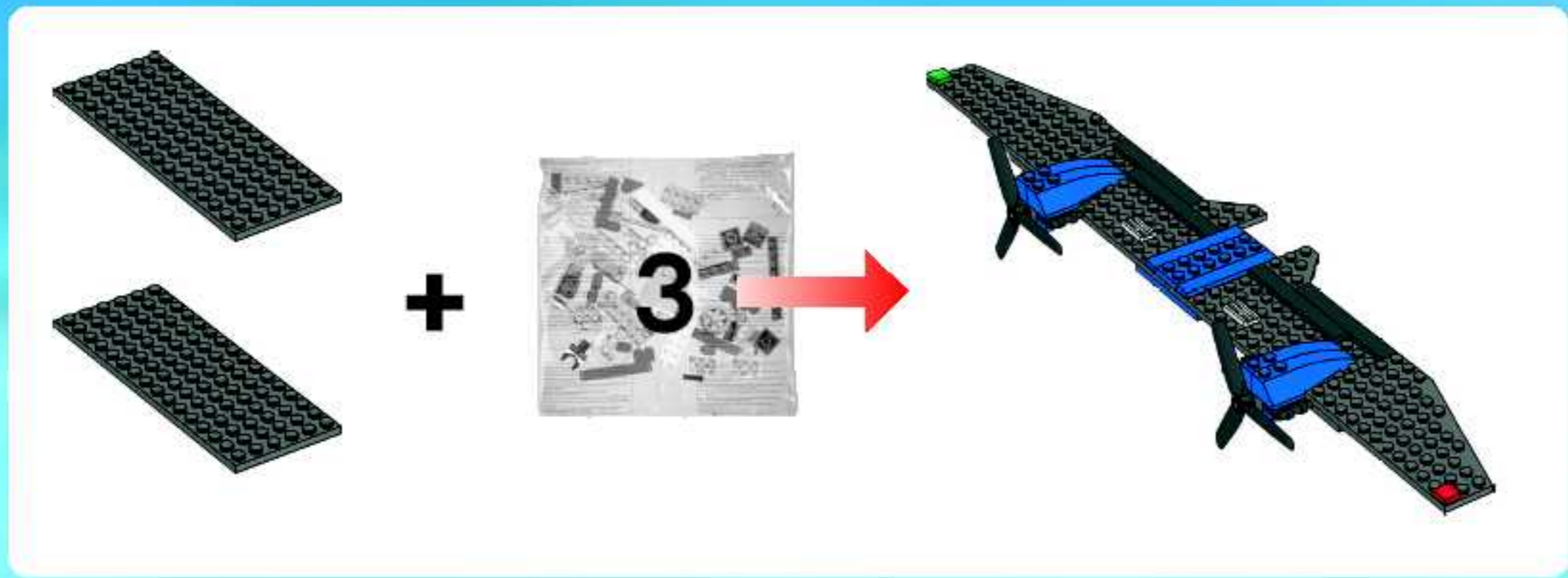

1

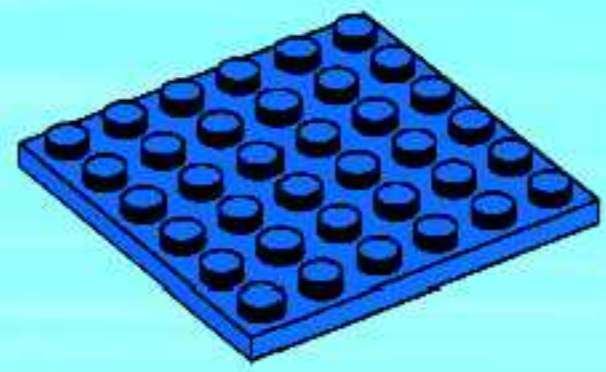

2

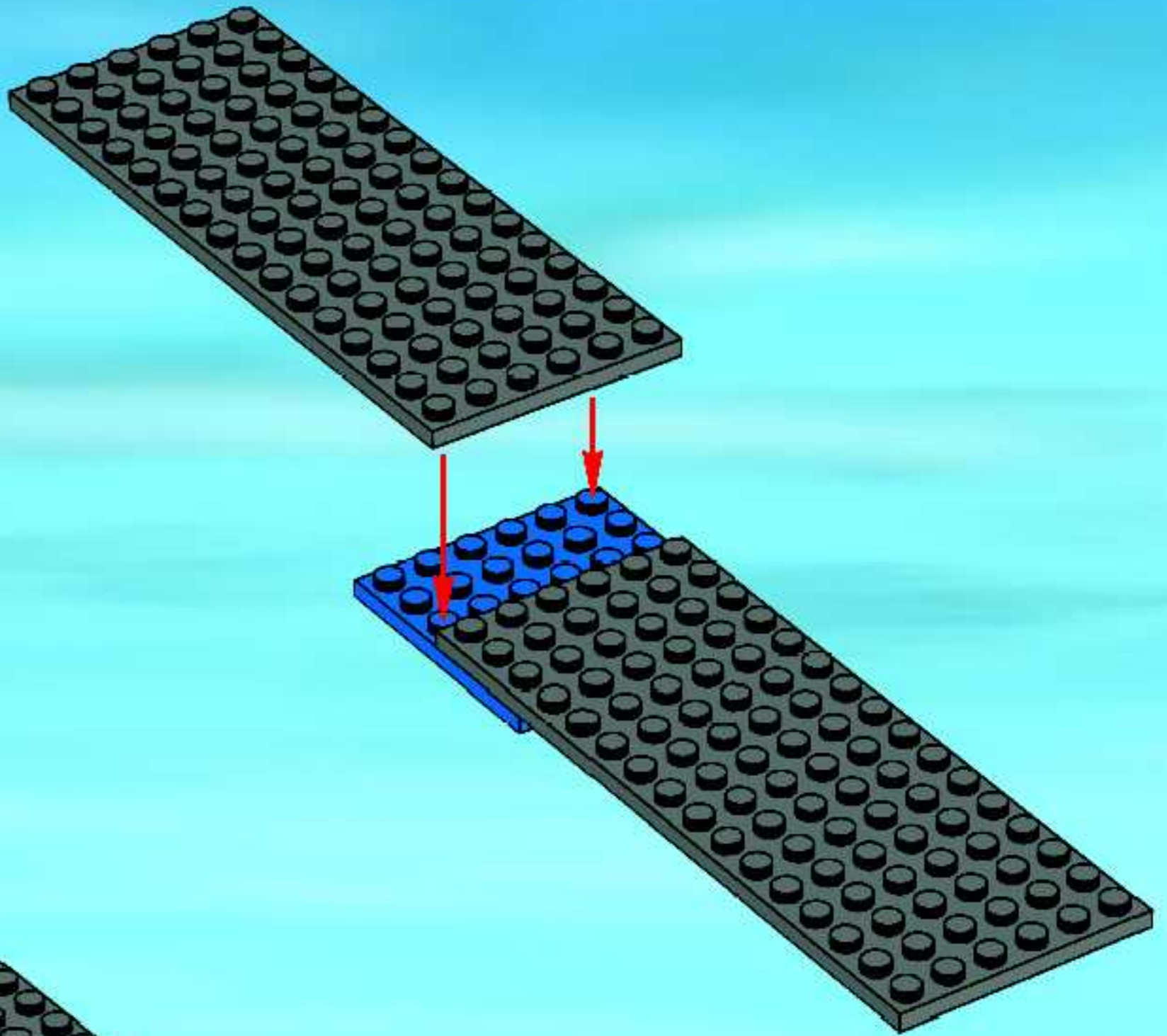

3

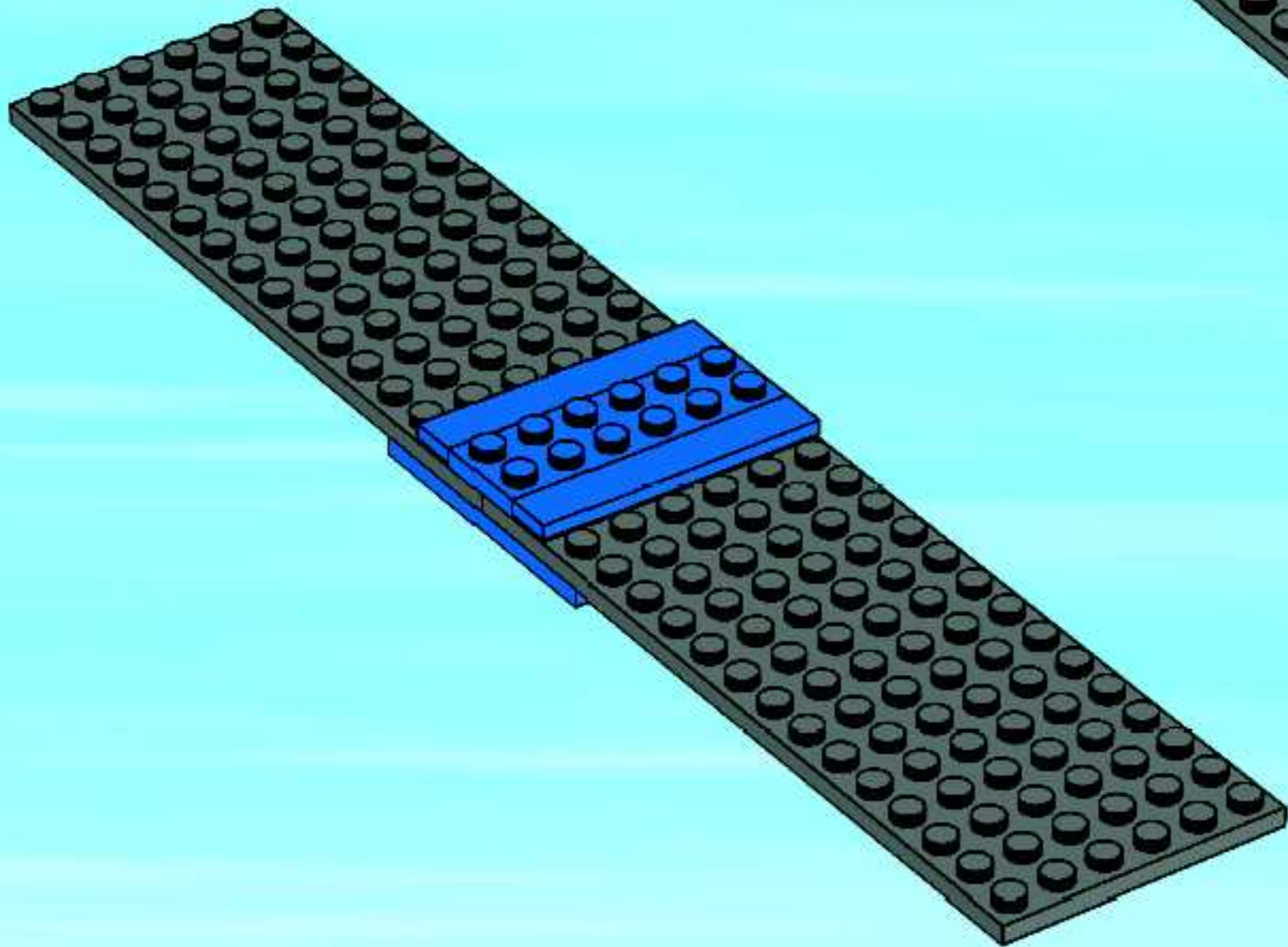

4

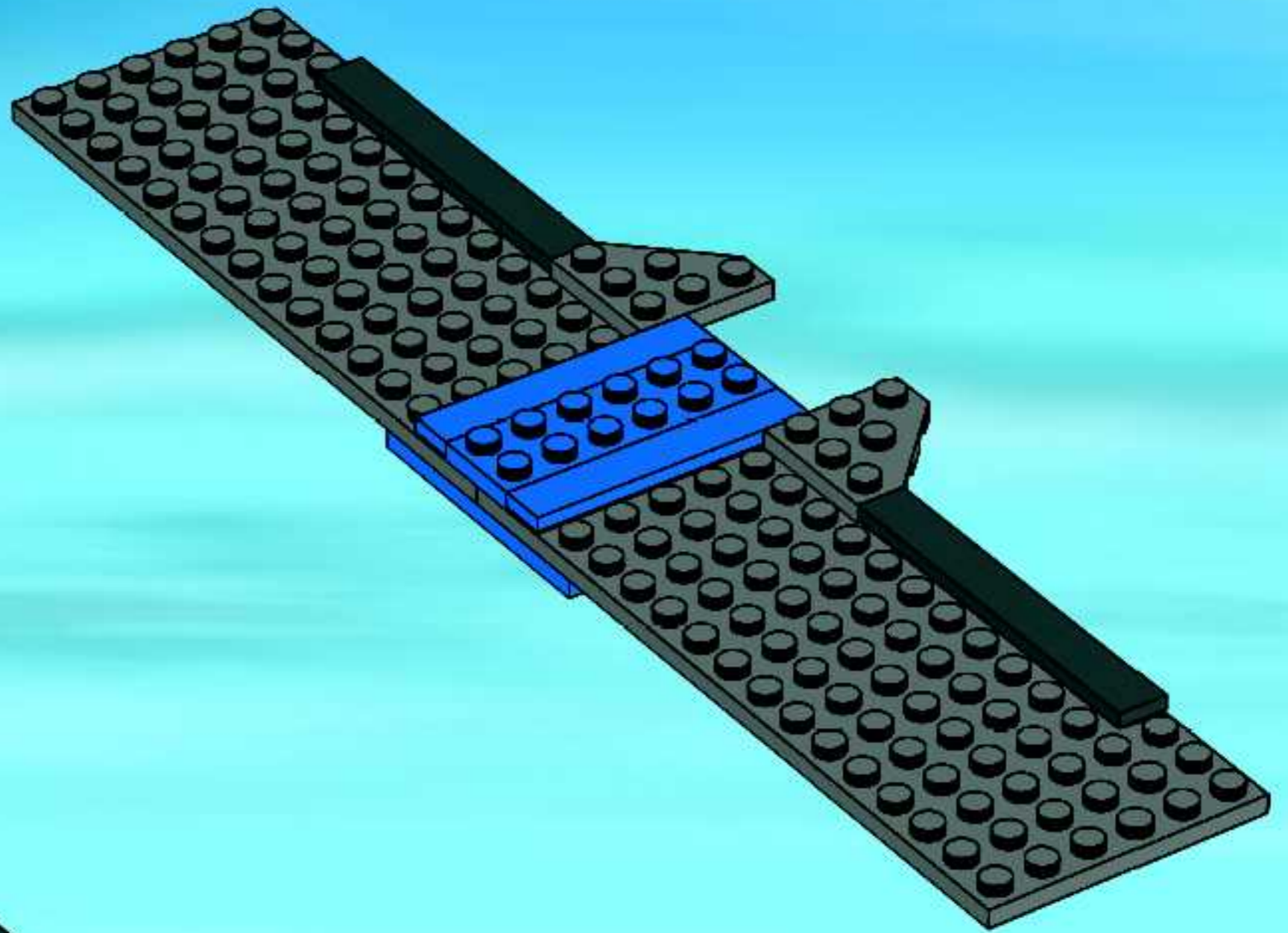

5

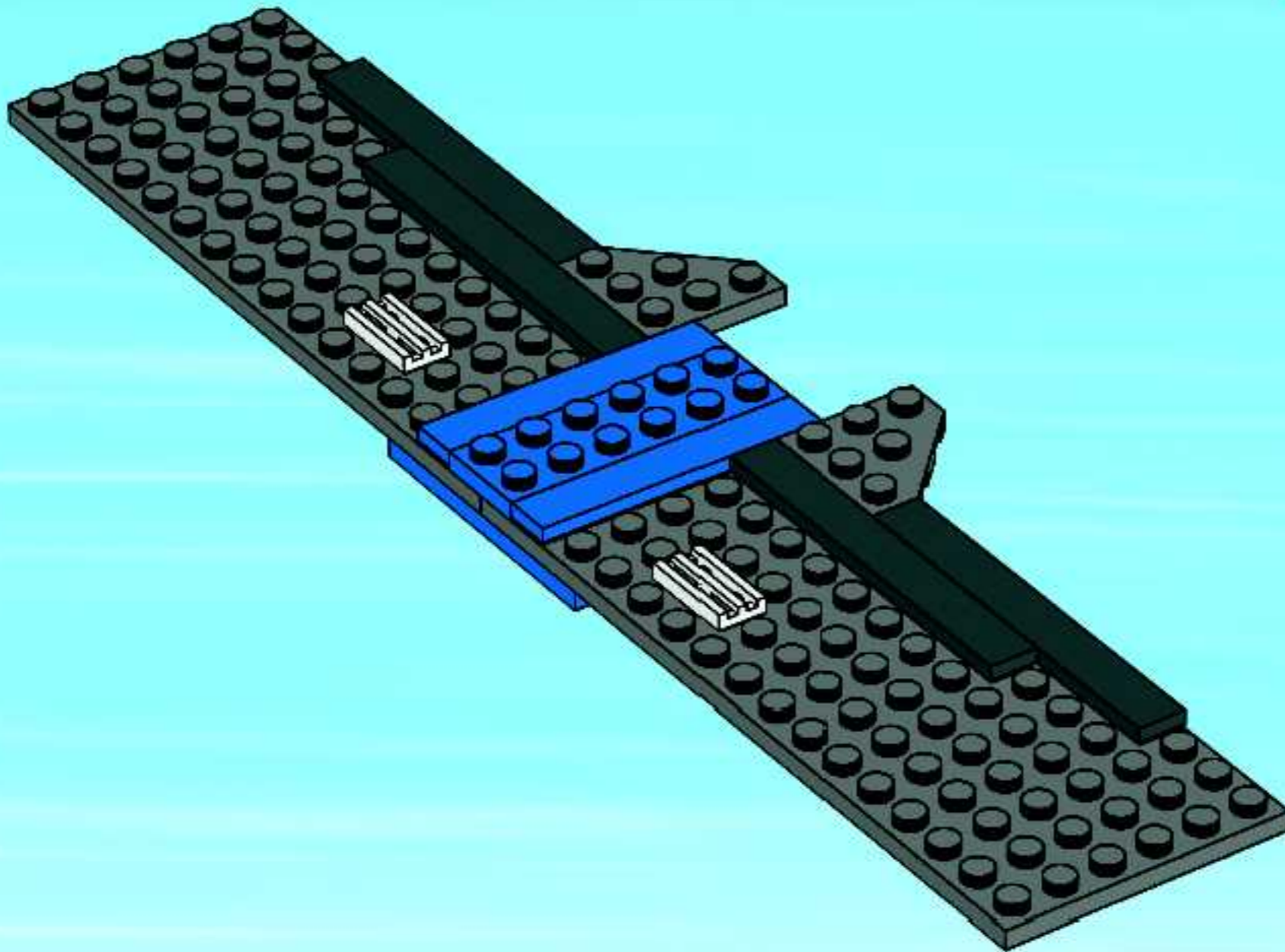

6

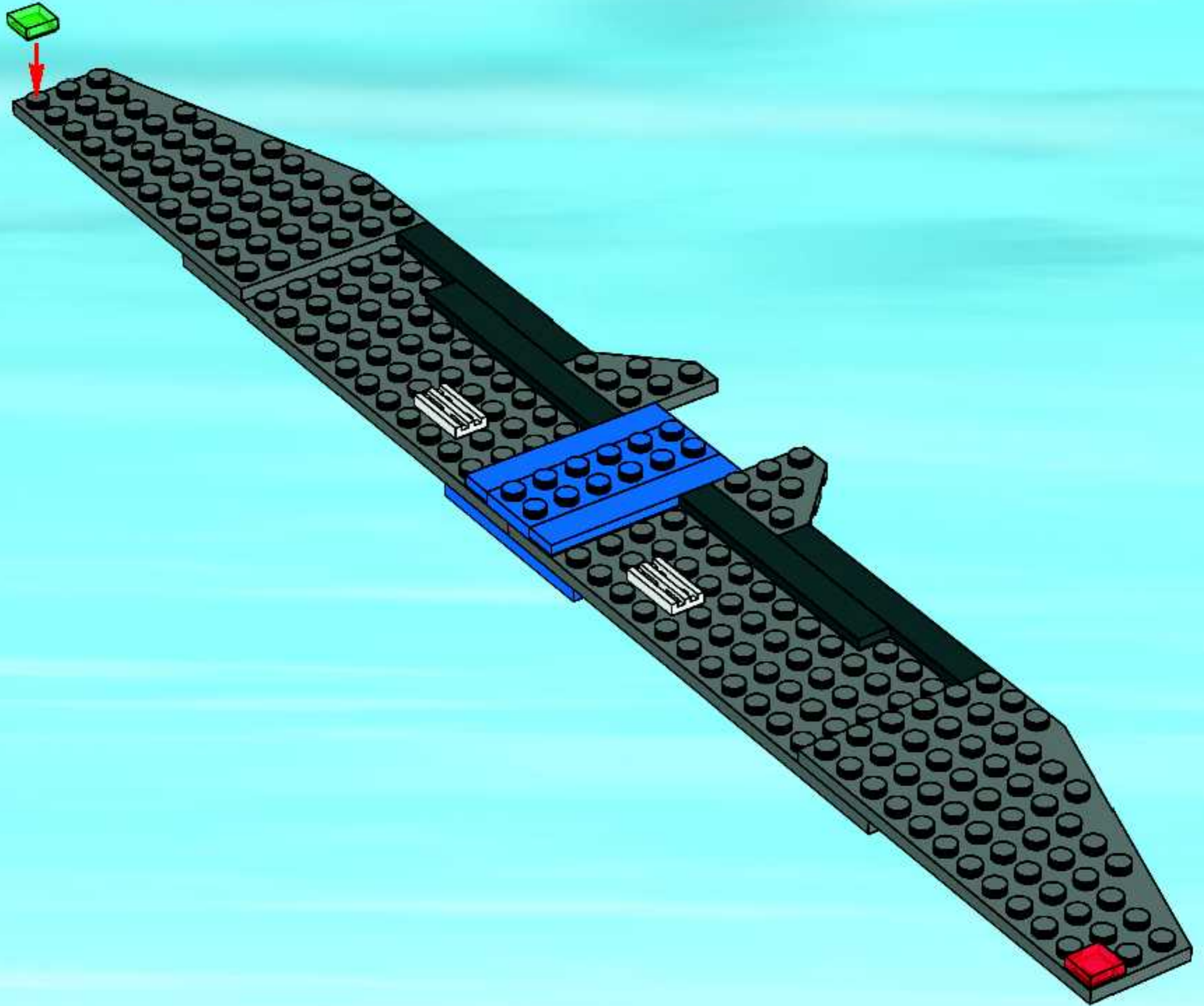

7

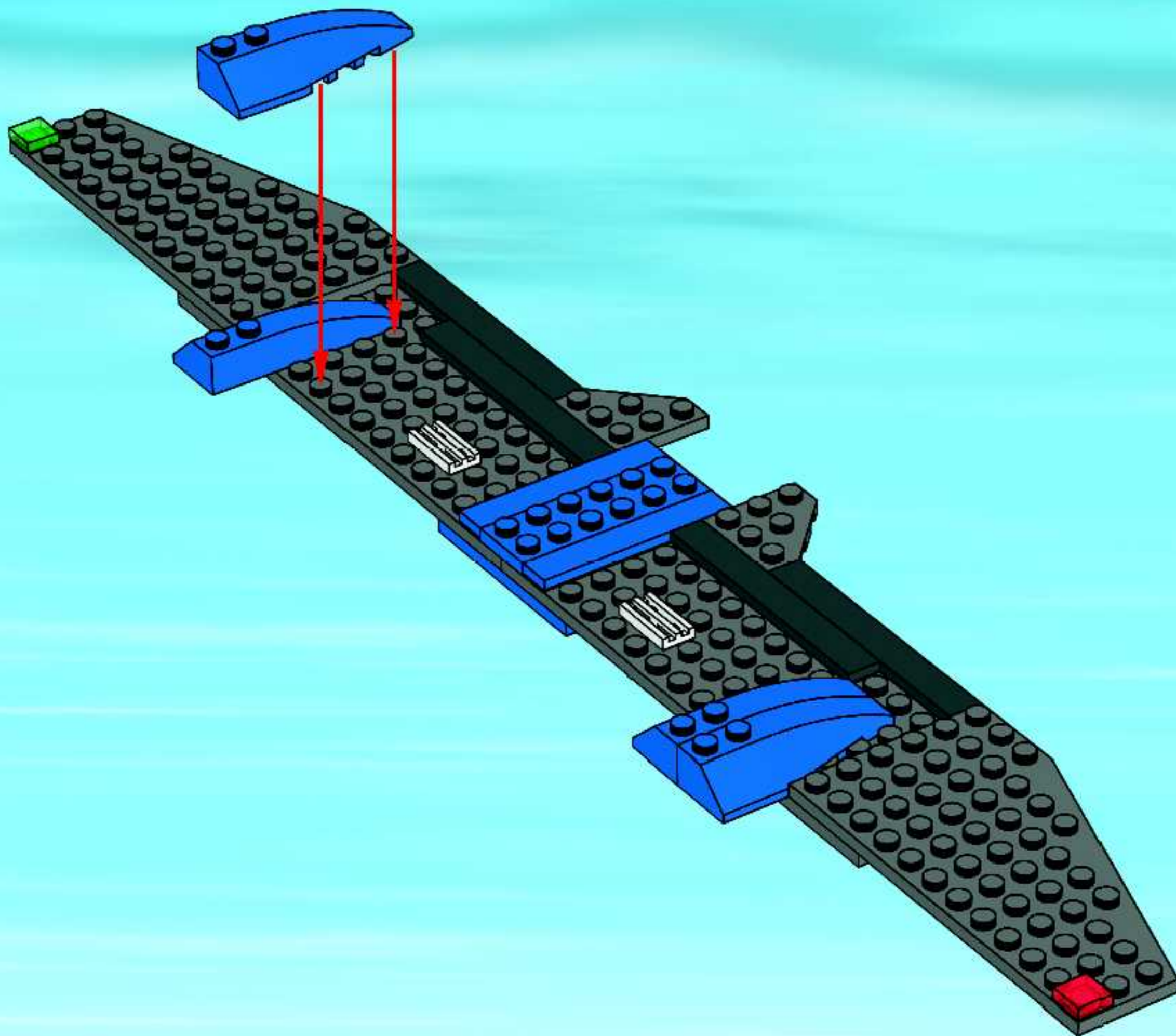

8

1

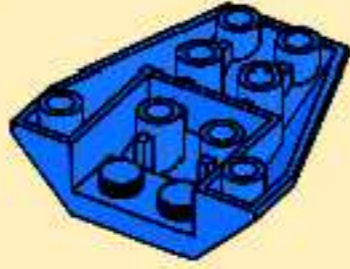

2

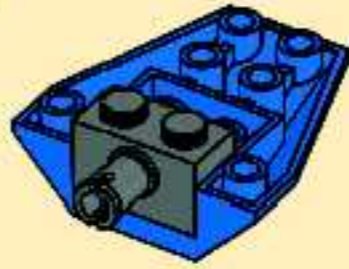

3



2x

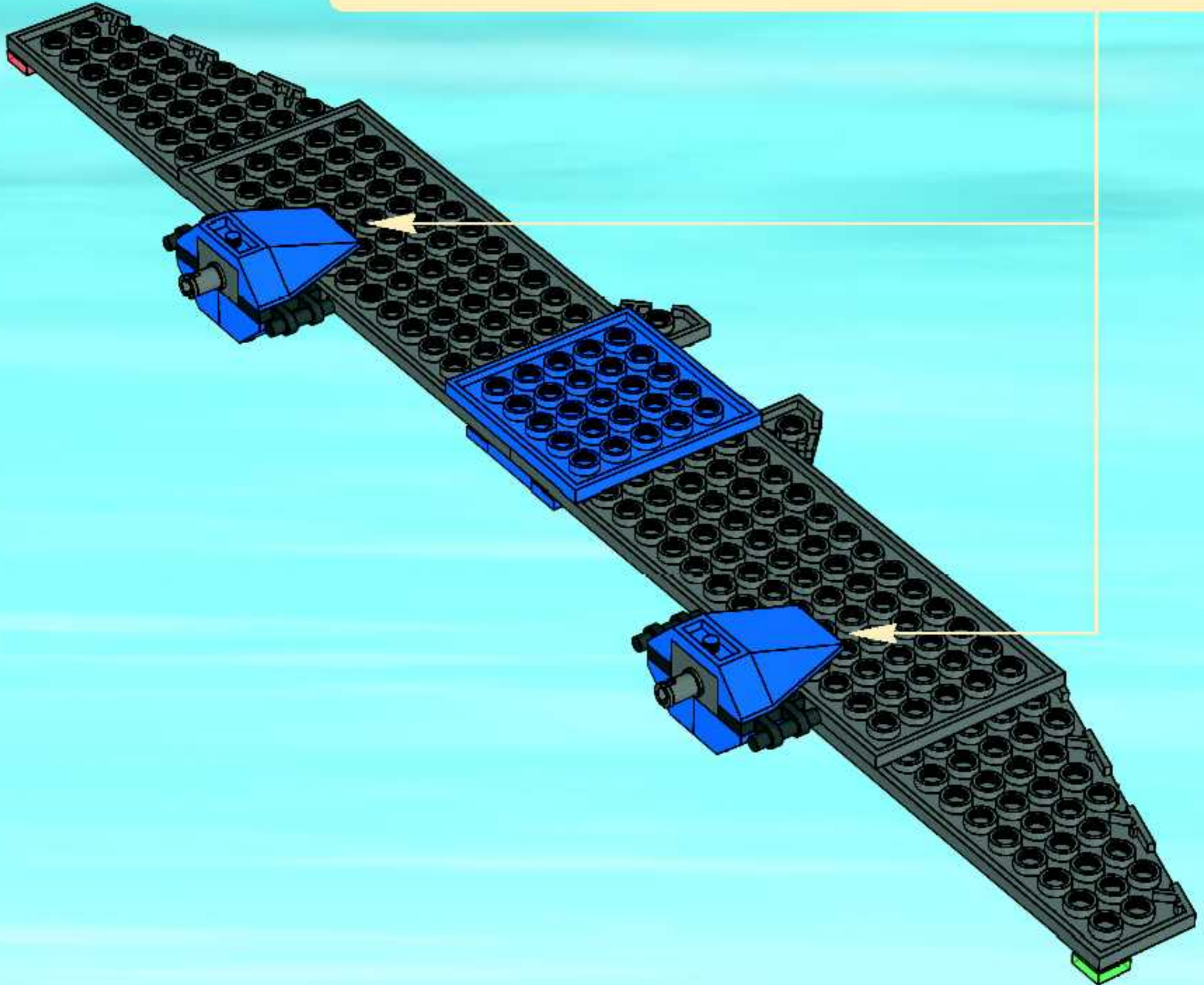

9

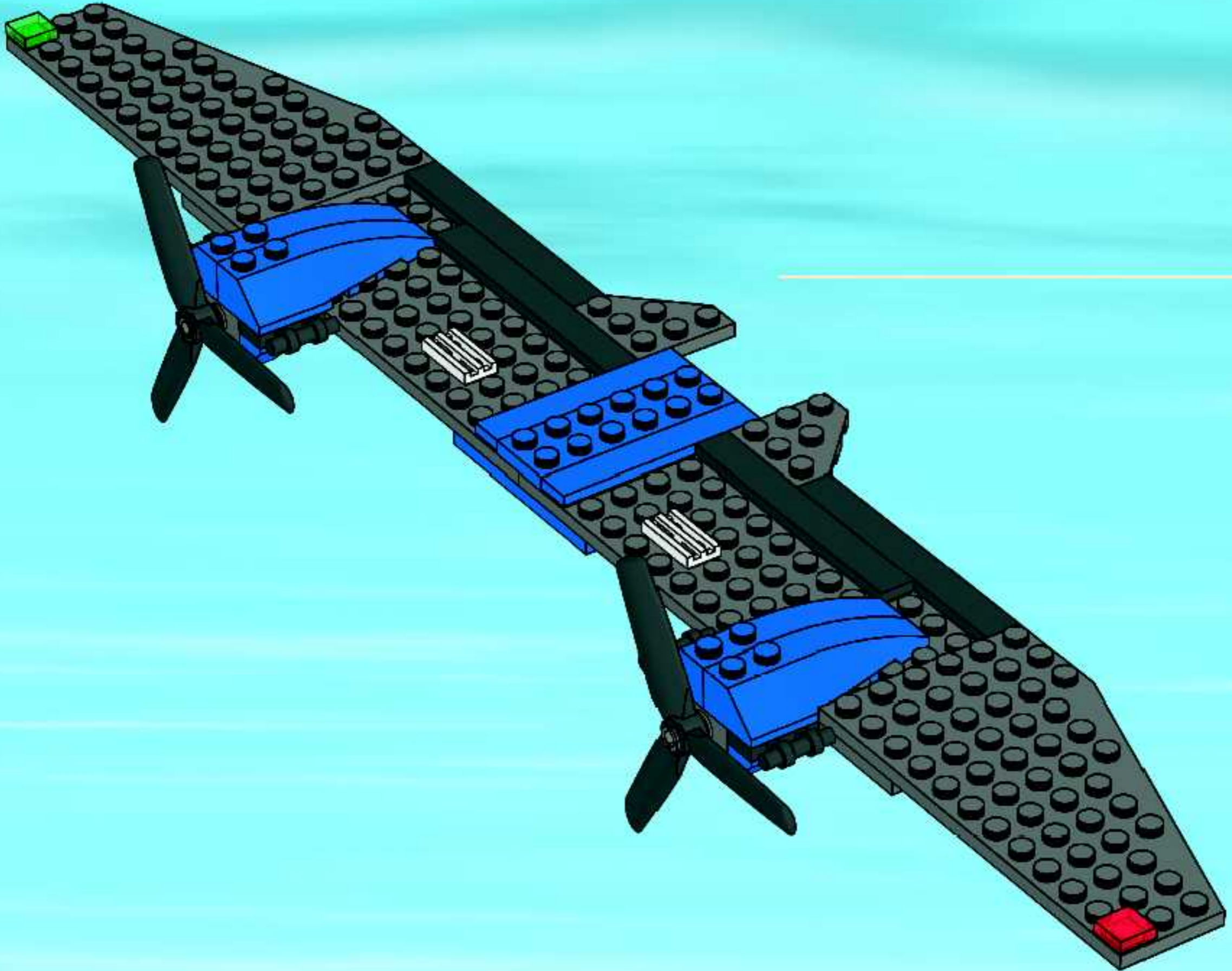



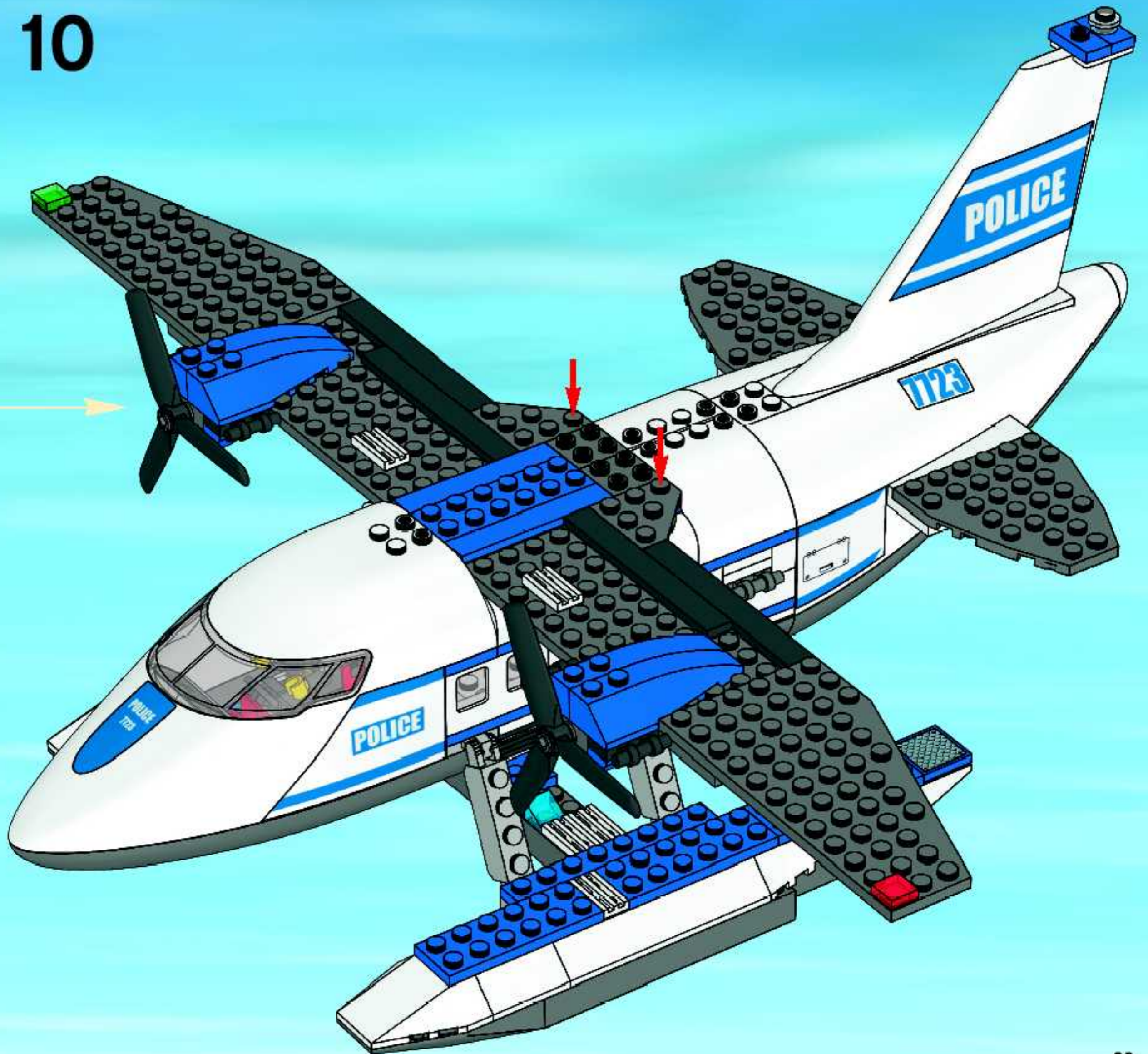

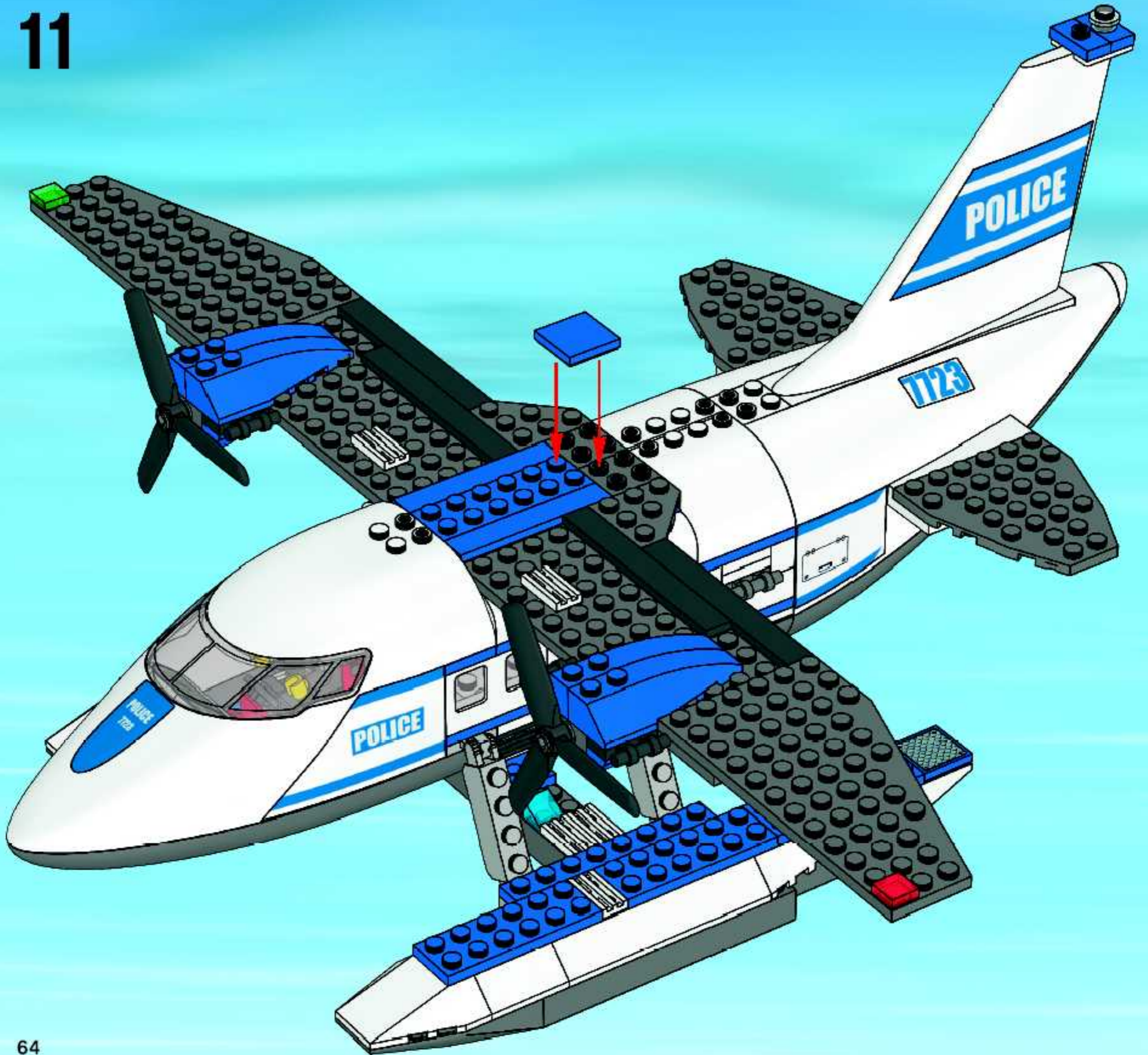





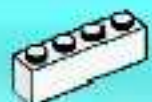



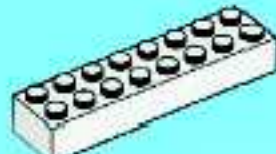







10





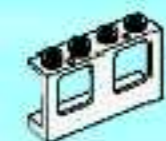

-  2x
4141668
-  4x
300401
-  4x
301001
-  2x
300301
-  2x
4179873
-  2x
4179872
-  1x
300701
-  2x
4519129
-  4x
235701
-  4x
608101
-  1x
243101
-  1x
306801

-  2x
4161723
-  5x
302301
-  3x
366601
-  1x
303501
-  9x
241201
-  2x
366501
-  2x
4500469
-  4x
4258358
-  2x
4163984
-  2x
4264026
-  3x
486501
-  4x
4521846

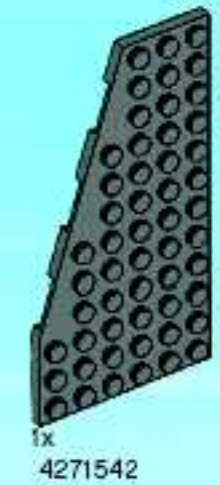
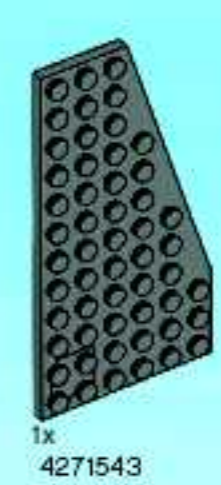
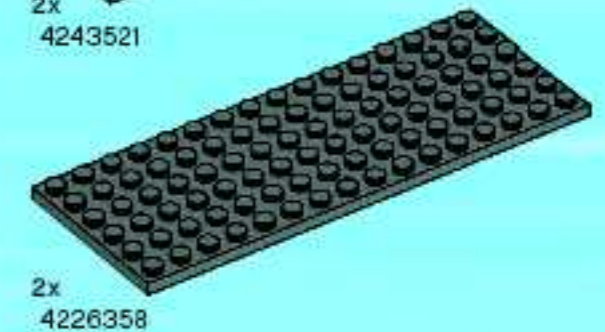
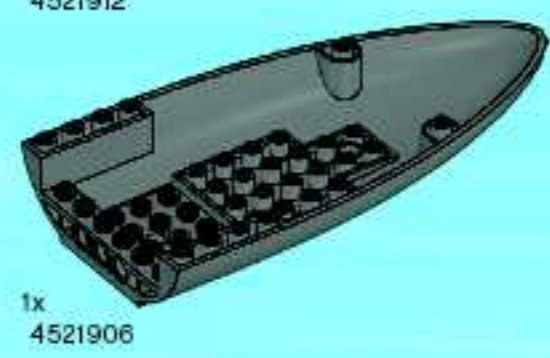
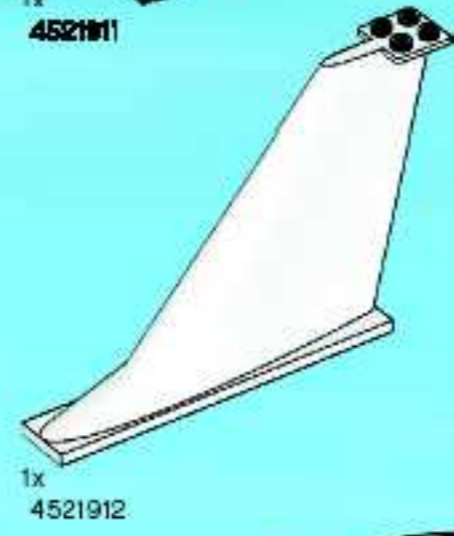
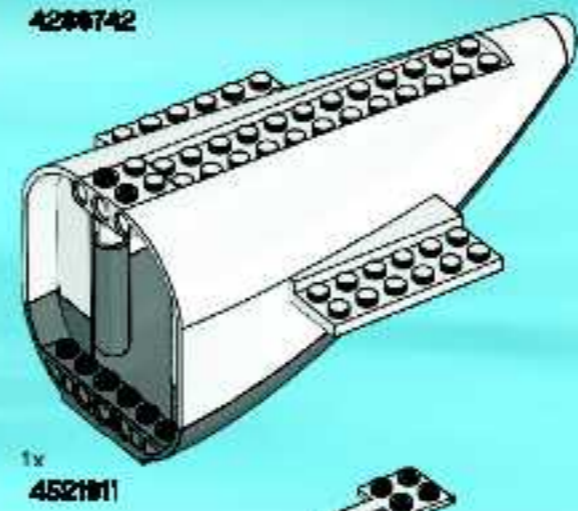

3x
302323

4x
379423

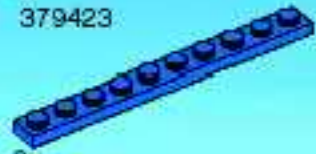

3x
447723



2x
371023



1x
366623

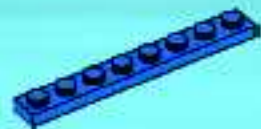

2x
346023



2x
4118785



3x
306823



4x
302423



3x
302023

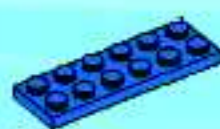

9x
379523



1x
4243815

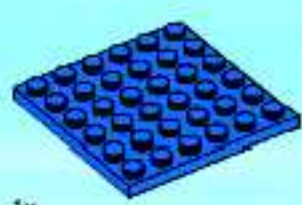

1x
4199519



2x
4296468

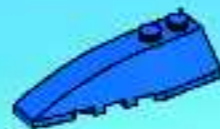

2x
4160128

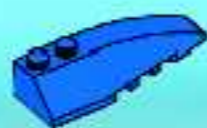

2x
4160106



2x
395623



1x
9552



2x
307021



2x
393721



4x
4244366



1x
3005740



1x
4216384



1x
3003941



8x
4520554



1x
4211640

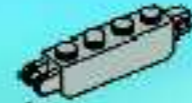

4x
4211695



4x
4215971



1x
4211464



4x
4211814



2x
4211409



4x
4278273



2x
4164073



1x
4259914

10x
4121715



4x
416226



1x
9339



1x
448526



1x
4275401



2x
393826



4x
4140588



2x
4142731



4x
241226



7235



7236



7245



7741



7743



7744



7731



7732



7733



7734

LEGO CITY



7241



7942



7239



7945

LEGO CITY



7990



7991



7992



7993



7994

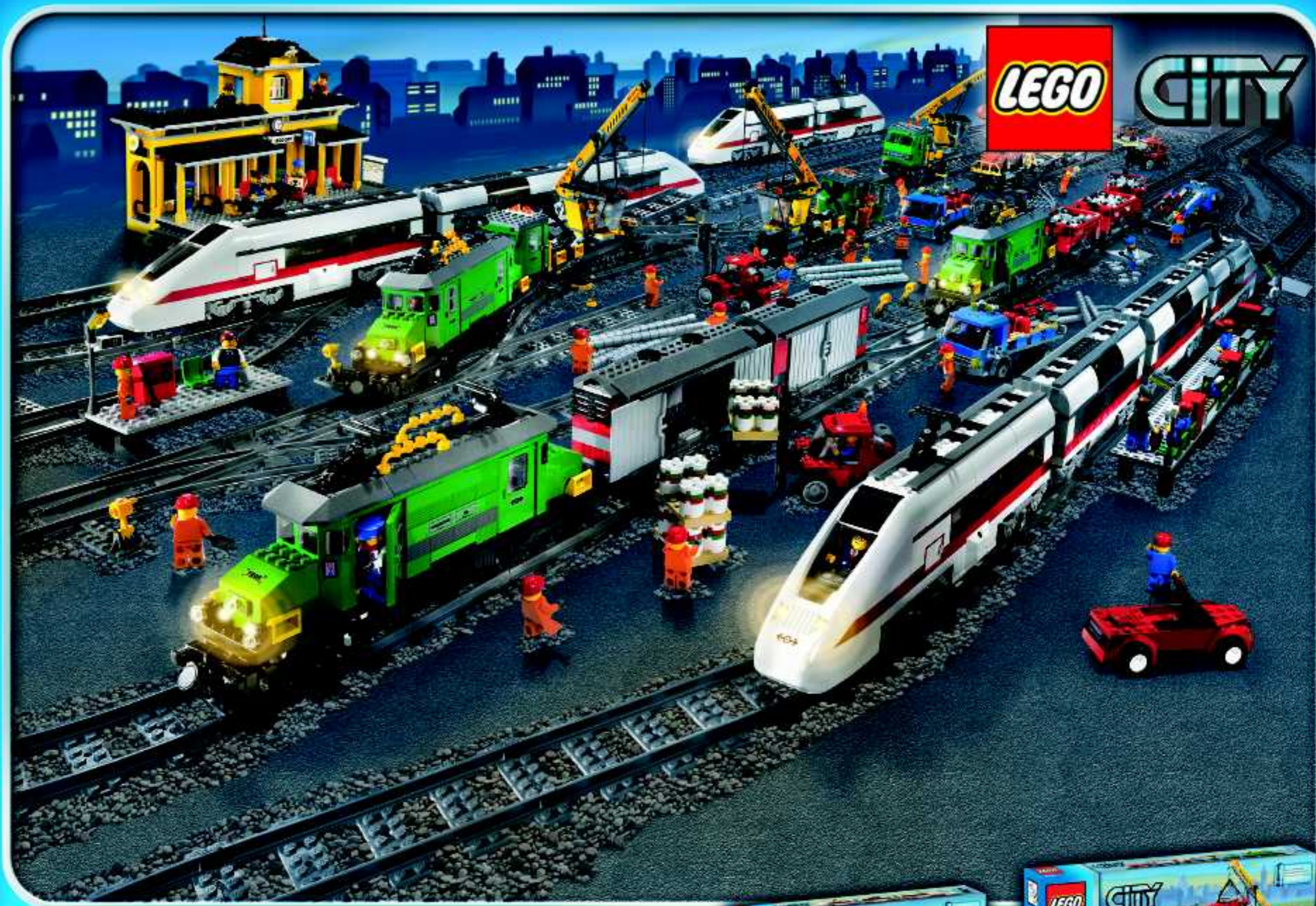

7896



7895



7996



7997



7897



7898



CITY

EXPLORE LOTS OF MOVIES, GAMES AND FUN DOWNLOADS

- Hier findest du viele tolle Filme, Spiele und Downloads
- Découvre de nombreux films, jeux et téléchargements amusants
- Explora montones de películas divertidas, juegos y descargas
- Explora imensos filmes divertidos, jogos e downloads
- Fedezz fel vidám filmeket, játékokat és letöltési lehetőségeket



 www.LEGO.com



YES! I want to join the LEGO® Club FREE!

BG27

OUI ! Je veux m'abonner au Club LEGO® GRATUITEMENT !

Ja! Ich möchte Mitglied im kostenlosen LEGO Club werden.

Ja! Ik wil graag GRATIS lid worden van de LEGO Club.



Mail to: / Poster à:

**LEGO Club
P.O. Box 1157
Enfield, CT USA
06083-1157**



Mail to:

**LEGO Club
33 Bath Road
Slough SL1 3UF
United Kingdom**



Per Post an:

**LEGO® Club
Postfach 14 15
D-36243
Niederaula**



Stuur op naar:

**LEGO® Club
Postbus 40252
3504 AB Utrecht**

First Name
Prénom
Vorname
Voornaam

Last name
Nom de famille
Familienname
Achternaam

Date of Birth
Date de naissance
Geburtsdag
Geboorte datum

Boy

Garçon
Junge
Jongen

Girl

Fille
Mädchen
Meisje

Street, No.
Rue
Straße, Hausnr.
Straat, huisnr.

City/County
Ville
Stadt
Woonplaats

State
Prov.

Zip/Postcode
Code Postal
PLZ
Postcode

Country
Pays
Land

Telephone
No de Téléphone
Telefonnr.
Telefoonnummer

Parent's signature
Signature d'un parent
Unterschrift Erziehungsberechtigte/r
Handtekening ouders

The English version of the magazine can only be mailed to addresses in the US, Canada, the UK, and Republic of Ireland. Club membership is valid for 2 years and includes free copies of the LEGO Magazine. In the US and Canada please allow up to 6 weeks for delivery of your first magazine. By signing this form you consent the LEGO Club to use your child's data for LEGO mailings. The data will only be used for LEGO mailings and will not be sold, rented or otherwise disclosed to any company outside the LEGO Company except for disclosure to companies acting as our agents to help us provide services requested by the child. This coupon good for one free membership per person, group or organization (photocopies not accepted).

La version française du magazine peut être postée uniquement au Canada. L'abonnement est valide pour 2 ans et inclut des exemplaires gratuits du Magazine LEGO. Aux É.-U. et au Canada, allouer 6 semaines pour la livraison initiale. En remplissant ce formulaire, vous consentez à ce que LEGO utilise les informations de votre enfant pour des envois postaux de LEGO. L'information sera utilisée uniquement pour des envois postaux par LEGO et ne sera en aucun cas, vendue, louée, échangée ou divulguée à d'autres compagnies autres que la compagnie LEGO, à l'exception des compagnies affiliées qui nous procurent des services auxquels l'enfant en a fait la demande.

Das deutschsprachige Angebot gilt nur für die Länder D, AU und CH. Die kostenlose Mitgliedschaft beinhaltet die Zusendung des LEGO Magazins und endet nach zwei Jahren. Für die Mitglieder entstehen keine Verpflichtungen. Es kann bis zu drei Monate dauern, bis das erste Magazin zugestellt wird. Mit Ihrer Unterschrift erklären Sie sich einverstanden, dass die Daten Ihres Kindes zum Zweck einer LEGO Club-Mitgliedschaft von der LEGO Gruppe gespeichert werden. Die Daten werden vertraulich behandelt und nicht an Dritte weitergegeben, außer an Dienstleister des LEGO Clubs. Wenn Sie außer vom LEGO Club keine weiteren Informationen von der LEGO Company bekommen möchten bitte hier ankreuzen:

Door dit formulier te tekenen geeft u de LEGO Club toestemming om bovenstaande gegevens te gebruiken voor het toesturen van LEGO mailings. Uw gegevens worden uitsluitend gebruikt voor mailings van LEGO en zullen niet worden verkocht, verhuurd of op welke wijze dan ook verstrekt aan derden buiten de LEGO Groep, uitgezonderd de organisaties die namens ons optreden om de service te verlenen waar uw kind om gevraagd heeft.

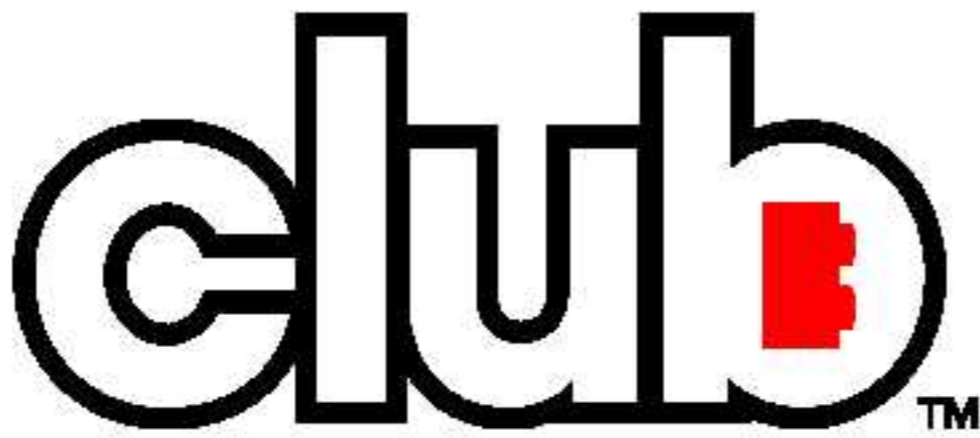

FREE LEGO Magazine • GRATUIT • GRATIS LEGO Magazin

Join Today!

Abonne-toi dès aujourd'hui !

Meld je nu aan!

Jetzt anmelden!



US & Canada only

1-866-534-6258 / 1-877-518-5346
(en Français)

00800 5346 5555

www.LEGOclub.com



VISIT THE
WORLD'S BIGGEST
LEGO® SHOP!
www.LEGOshop.com

www.acnielsen.aim.dk/LEGO



WIN LEGO® PRODUCTS

No purchase necessary.
Open to residents of all countries where
not prohibited.
Go to www. for official rules and details.

WIN LEGO® PRODUCTEN

Kopen niet nodig.
Open voor alle leeftijden, en in alle landen
waar geen verbod geldt.
Ga naar www. voor officiële regels en details.

GEWINNE LEGO® PRODUKTE

Die Teilnahme am Gewinnspiel führt zu
keinerlei Kaufverpflichtungen.
Sie können in allen nicht ausgeschlossenen
Ländern teilnehmen.
Die offiziellen Regeln und nähere Informationen
finden Sie unter www.

GAGNE DES PRODUITS LEGO®

Aucun achat n'est nécessaire.
Ouvert à tous les âges et aux résidents de
tous les pays, sauf en cas d'interdiction.
Rendez-vous sur www. pour obtenir plus
de détails et le règlement officiel.

レゴ®製品を「当てよう」

購入は不要です
禁止されていない限り、あらゆる
年代およびあらゆる国の居住者の
方々にご利用いただけます。
公認規則および詳細につきましては、
www.をご覧ください

