



どうぶつの森

77048



LEGO® Builder



LEGO.com/sustainable-packaging



FR
DONNEZ
OU
RECYCLEZ



OU



OU



ASSOCIATION

MAGASIN

DÉCHÈTERIE

Adresses sur quefairedemesdechets.fr

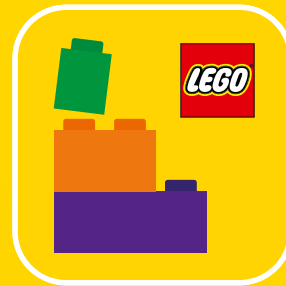

BUILDER



Apple and the Apple logo are trademarks of Apple Inc., registered in the U.S. and other countries and regions. App Store is a service mark of Apple Inc. Google Play and the Google Play logo are trademarks of Google LLC. Tencent and the Tencent logo are trademarks of Tencent Inc.

LEGO.com/devicecheck

EN Ask parents' permission before going online | **DE** Eltern um Erlaubnis bitten, bevor du online gehst | **FR** Demande l'autorisation d'un parent avant d'aller en ligne | **IT** Chiedi il permesso ai tuoi genitori prima di andare online | **ES** Pídeles permiso a tus papás antes de conectarte a Internet | **PT** Peça autorização aos pais antes de acederes online | **ZH** 上网前应先征得父母的同意 | **PL** Poproś rodziców o zgodę, zanim wejdiesz do Internetu | **CS** Než půjdeš na internet, požádej rodiče o svolení | **SK** Skôr než pôjdeš na internet, vypýtaj si povolenie od rodičov | **HU** Kérj szülői engedélyt, mielőtt online csatlakoznál! | **RO** Cere permisiunea părinților înainte de a te conecta online | **BG** Поискайте разрешение от родител, преди да влезете онлайн | **LV** Pirms došanās tiešsaistē palūdz atļauju vecākiem | **ET** Enne Interneti kasutamist küsi vanematelt luba | **LT** Prieš prisijungdami prie interneto, atsilkauskite tėvų

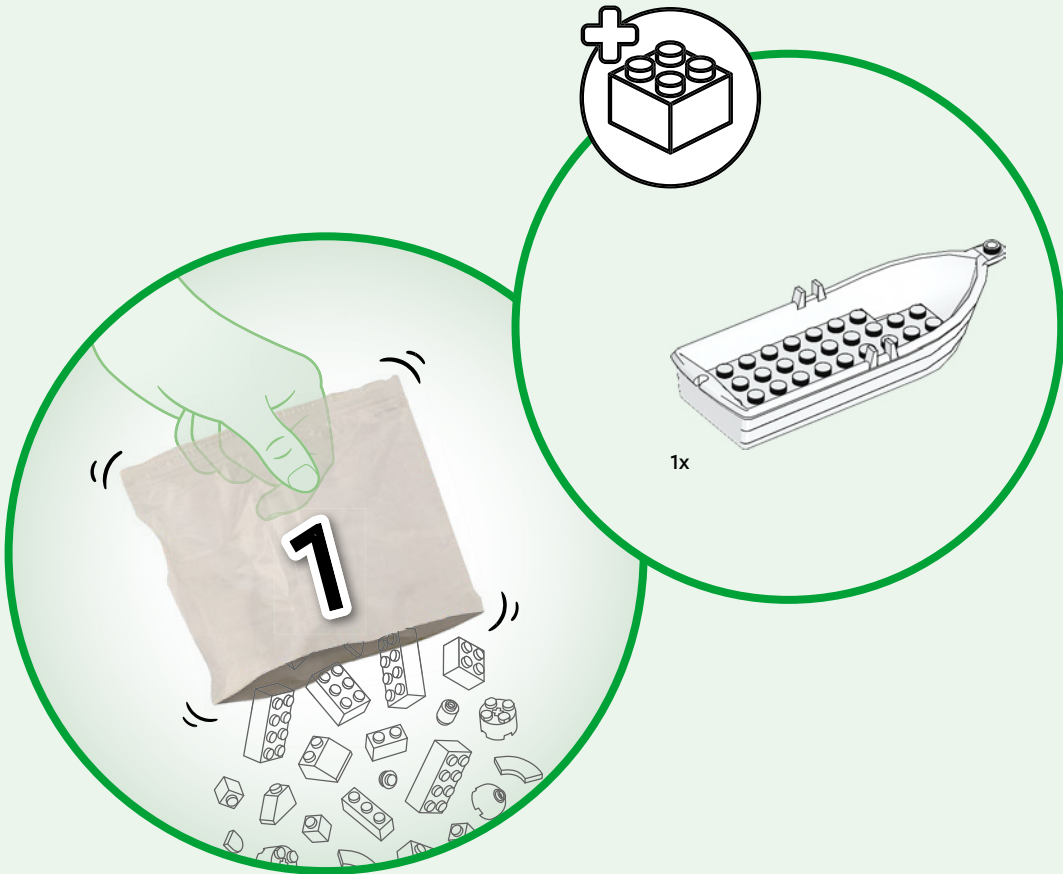

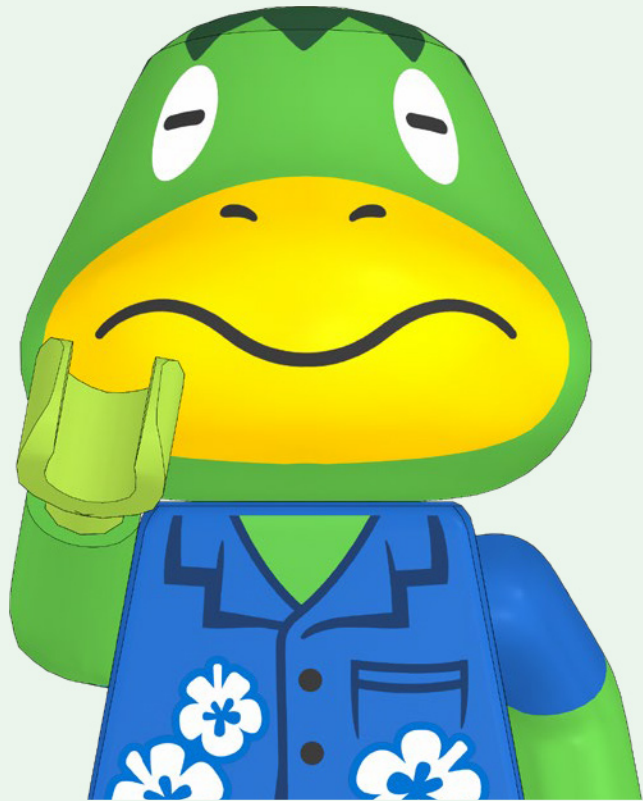
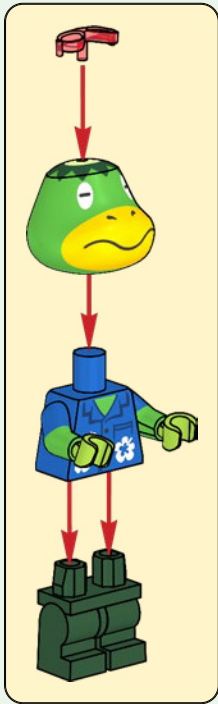

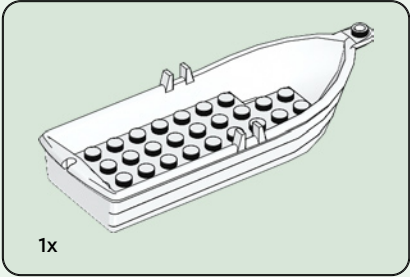
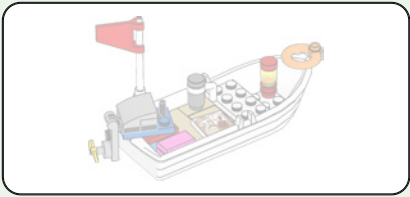

1

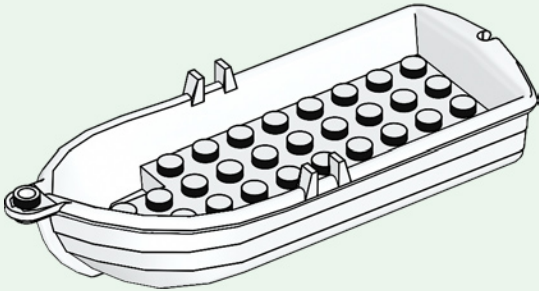



2x

2

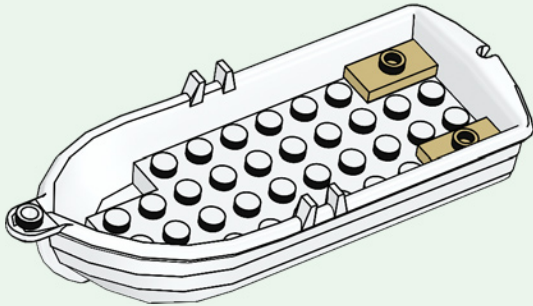

1x

3

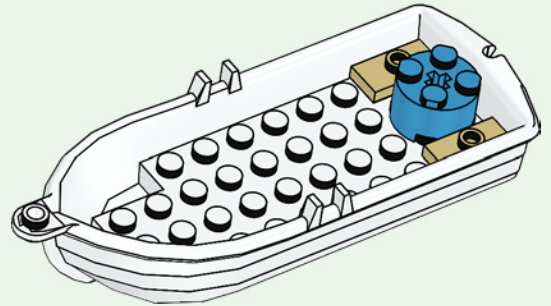

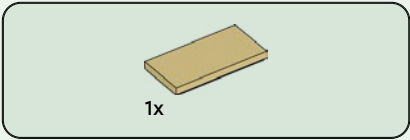

4

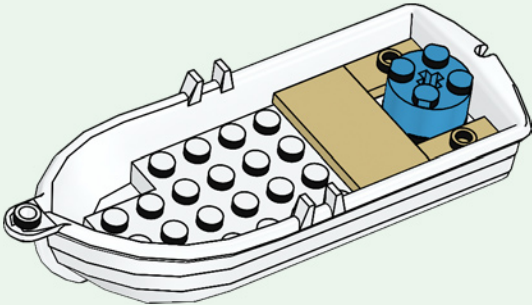

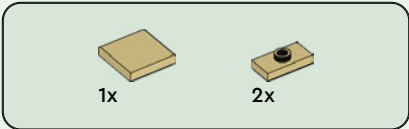

5

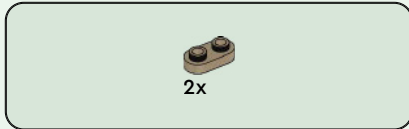
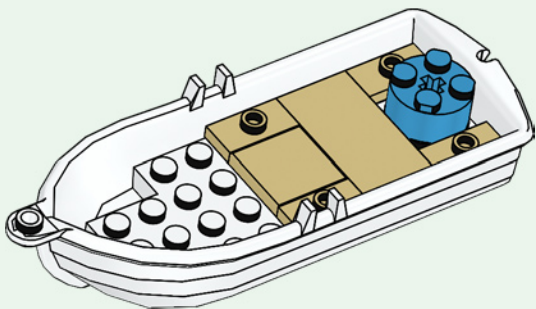

6

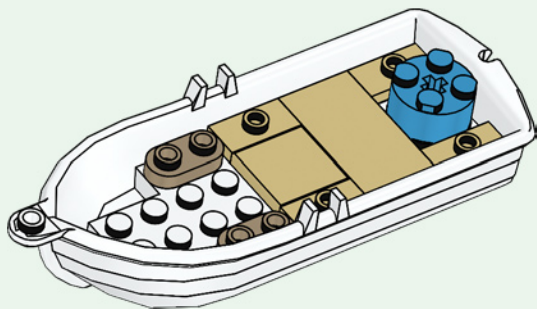



1x

7

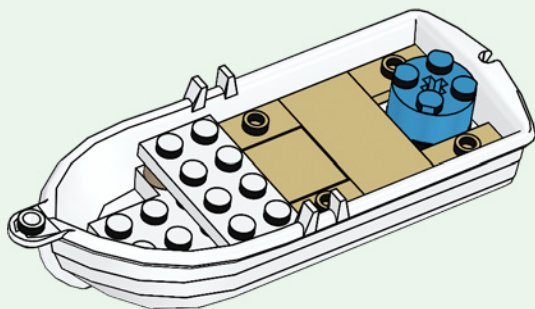

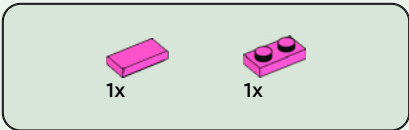

8

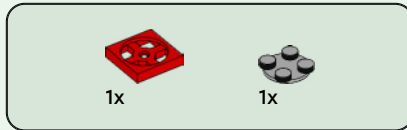
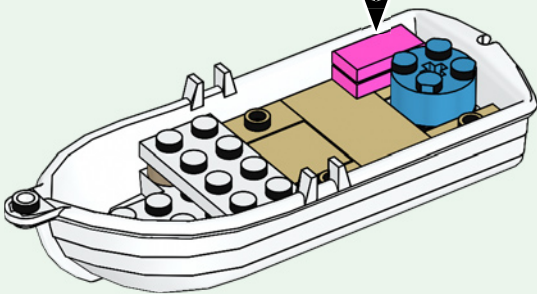
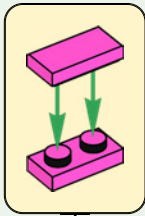

9

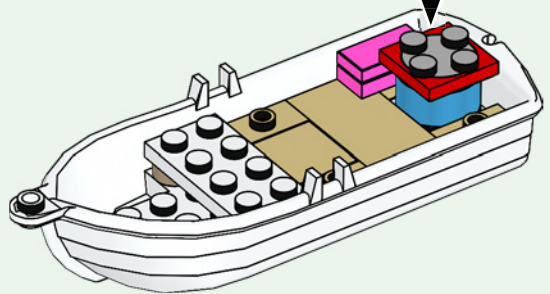
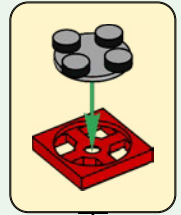

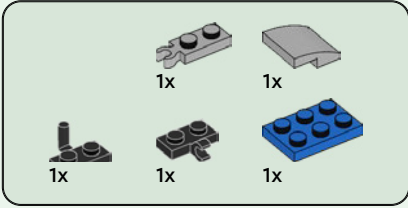

10

1

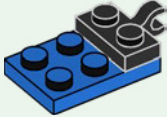

2



3



4

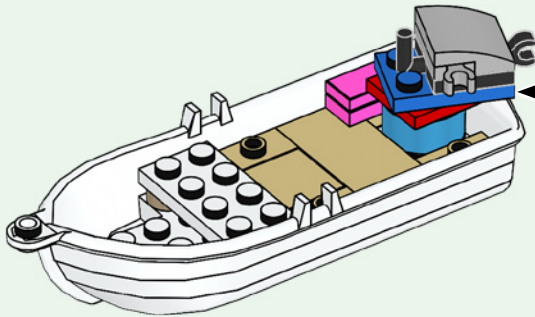
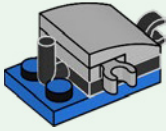

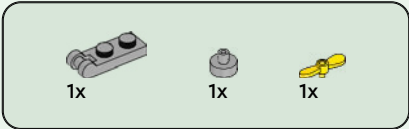

11

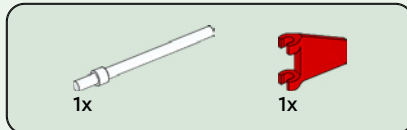
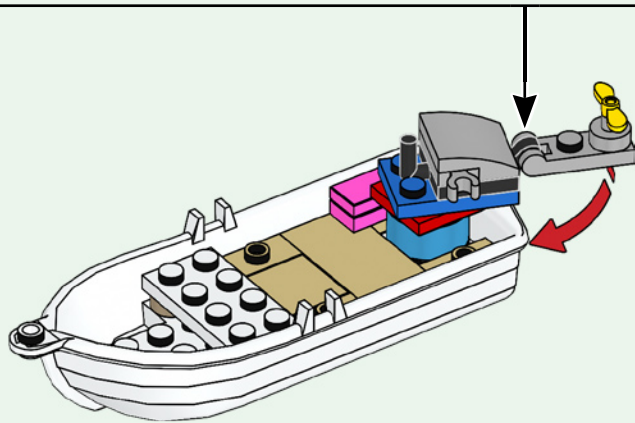
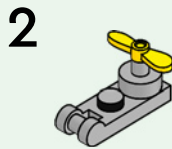
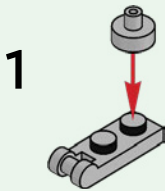

12

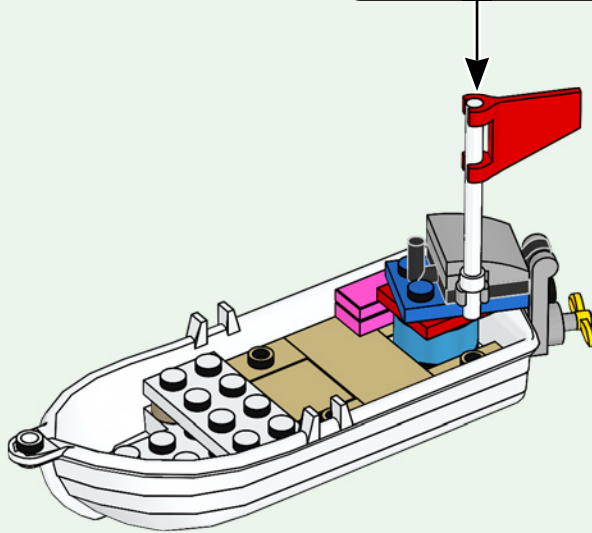
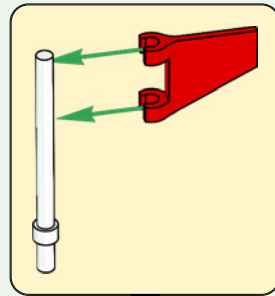



13

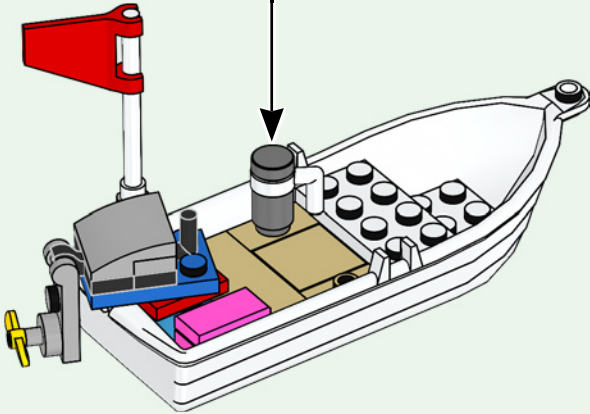
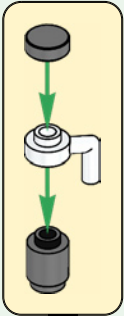

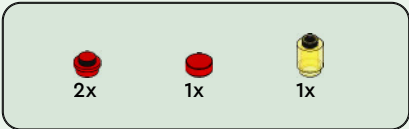

14

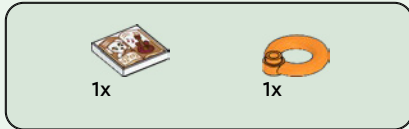
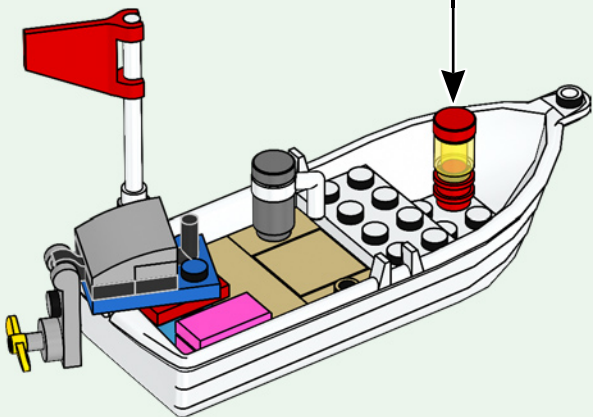
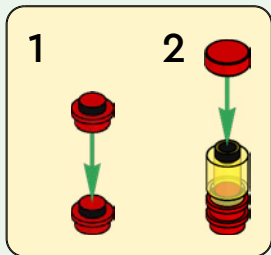

15

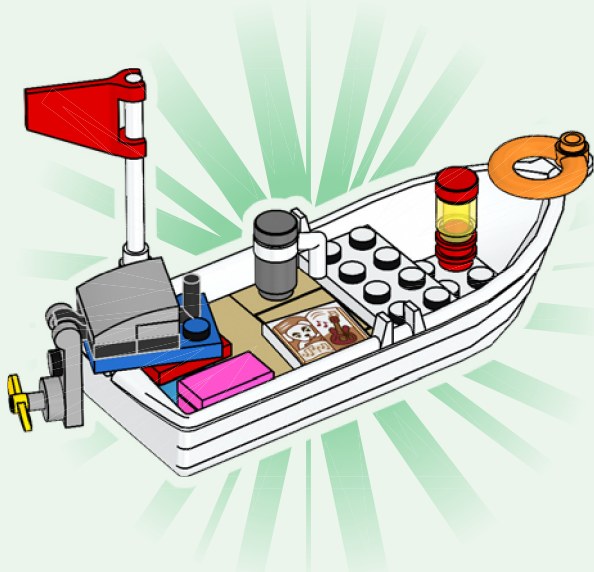



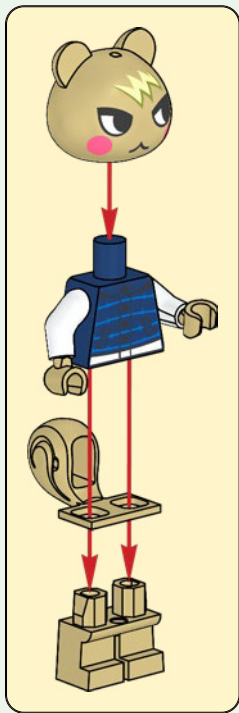

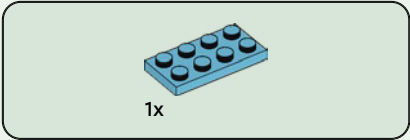
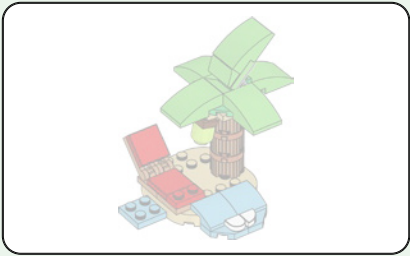

1

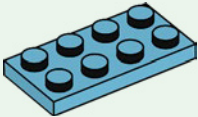

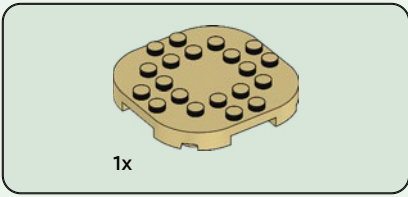

2

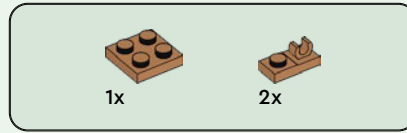
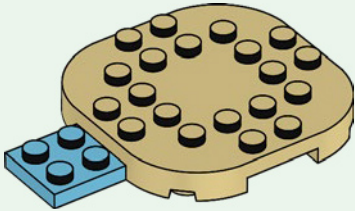

3

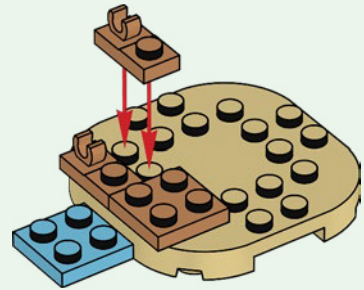



1x



1x

4

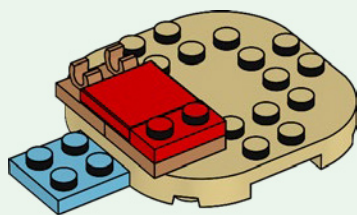

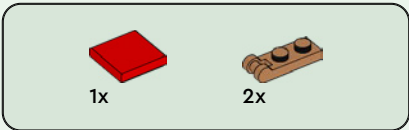

5

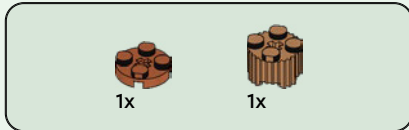
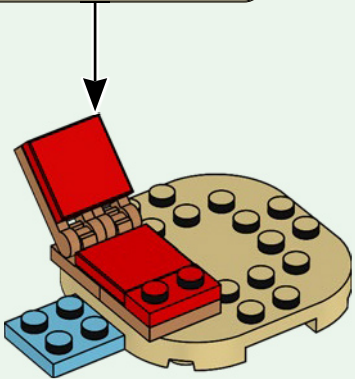
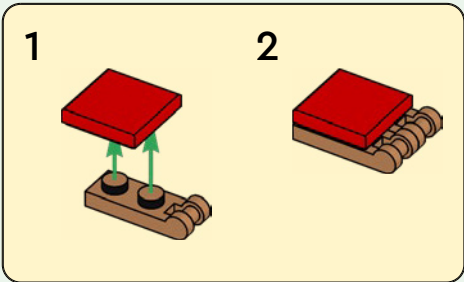

6

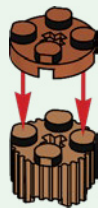

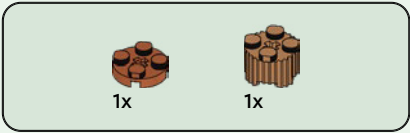

7

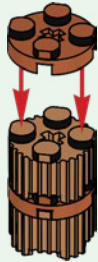



8

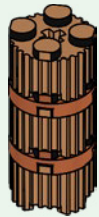

9

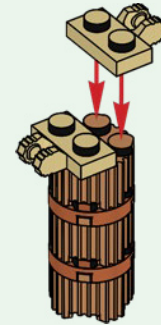



1x

10



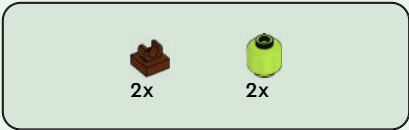

11

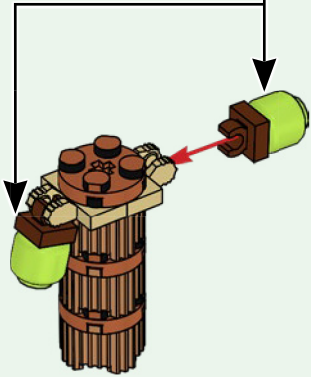
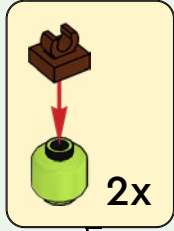

12



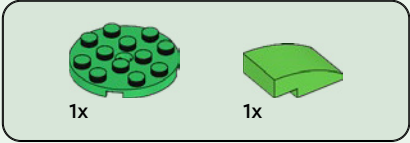
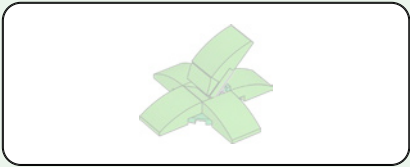

13





1x



1x

14

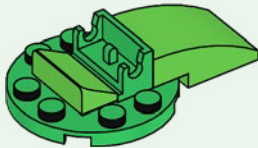

1x

15

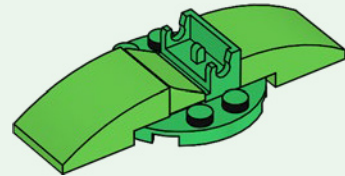



2x

16

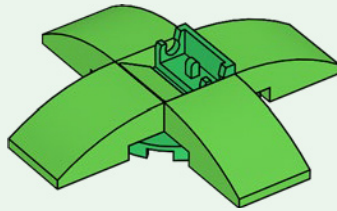



17

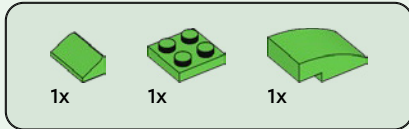
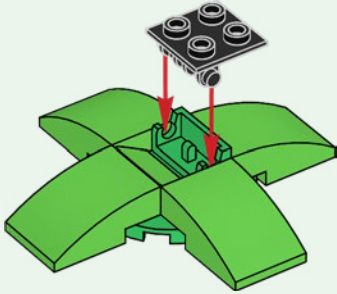

18

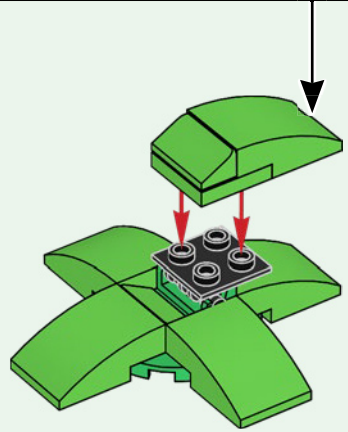
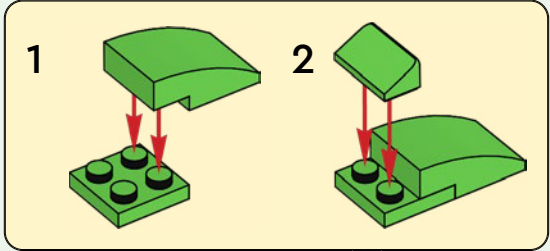

19

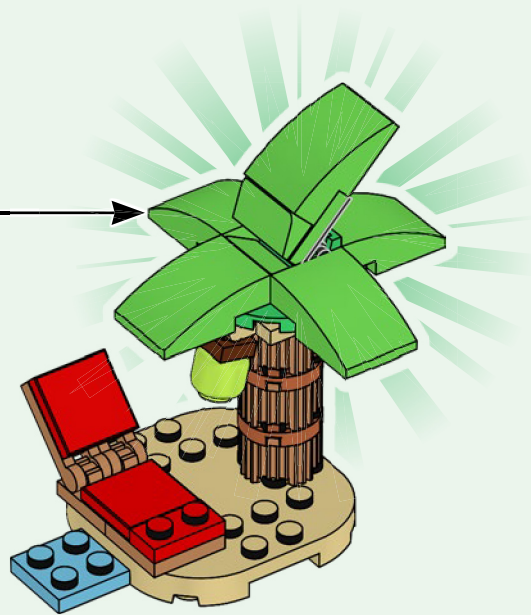



2x

20



2x

21





1x



1x

22



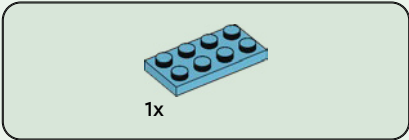
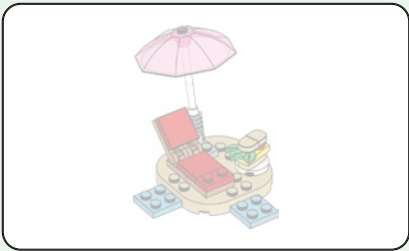

1x

23

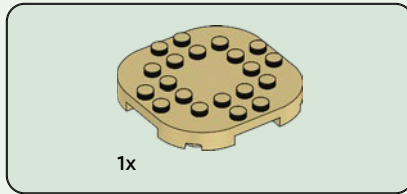
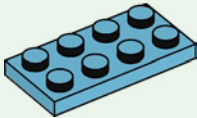

1x

24

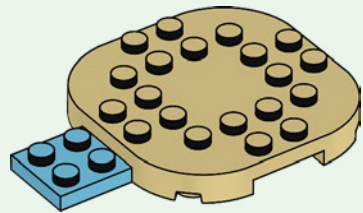



1x

25

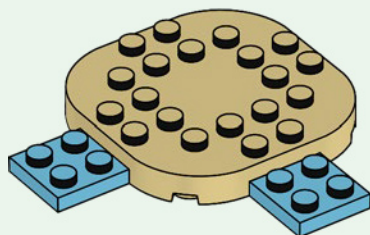



1x



2x

28

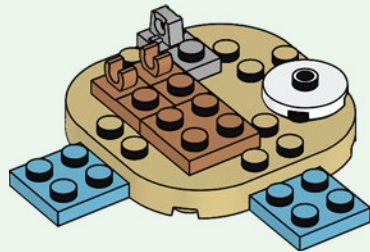

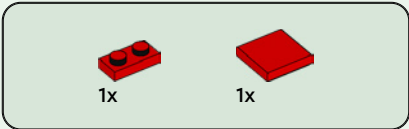

29

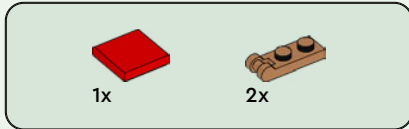
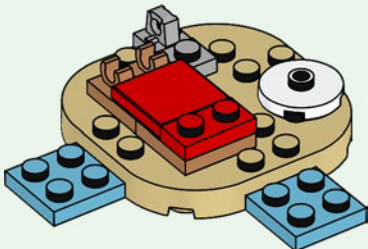

30

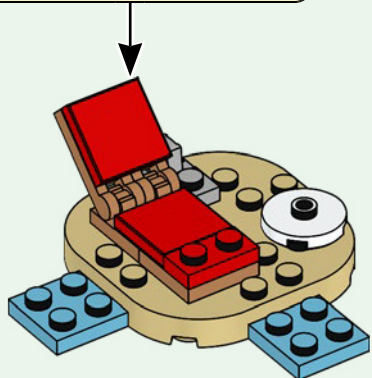
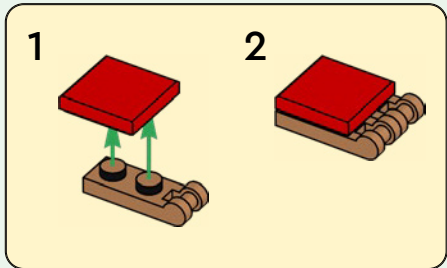

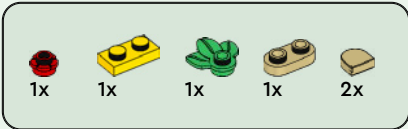

31

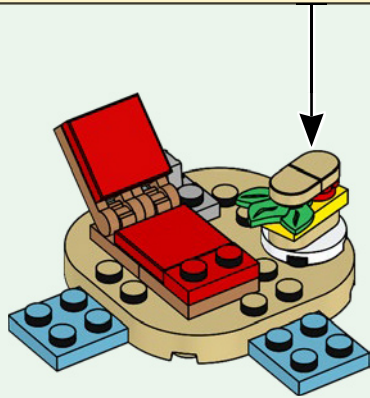
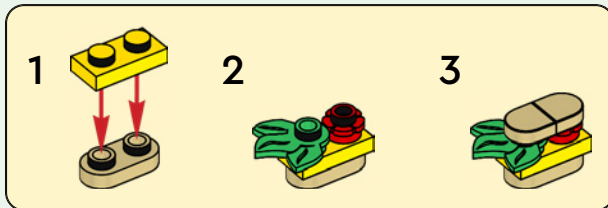

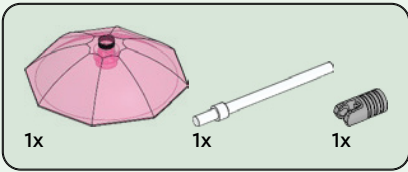

32

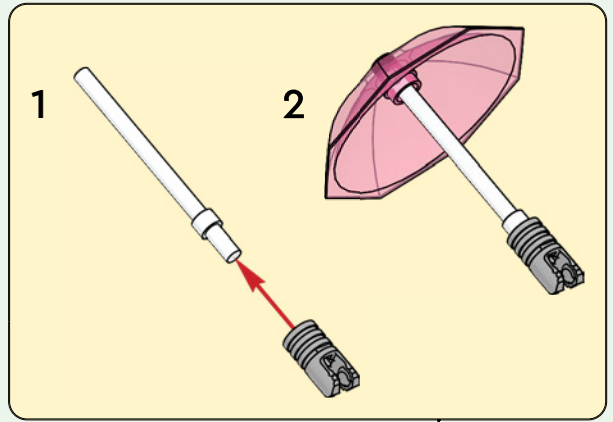

33



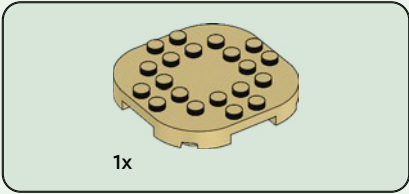
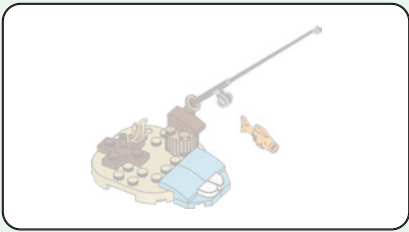

34

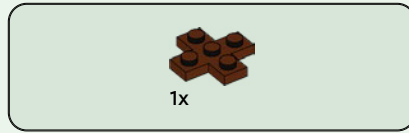
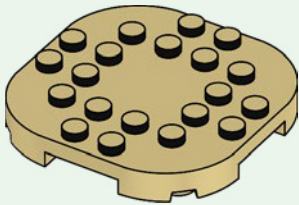

35

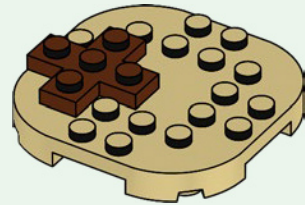



1x



1x

36

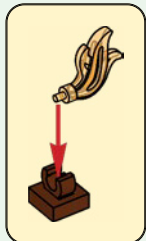

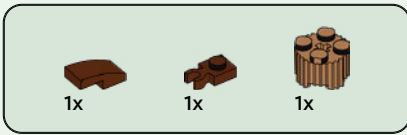

37

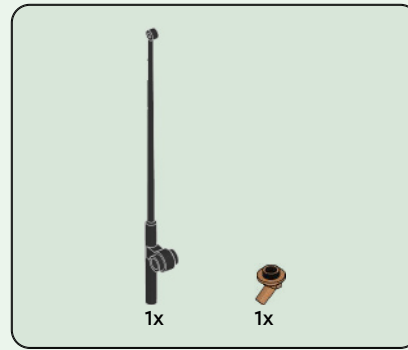
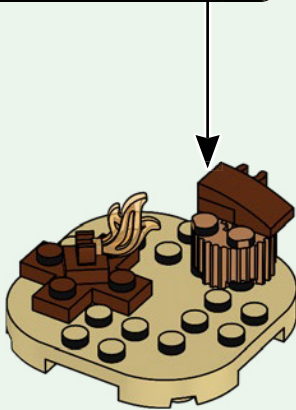
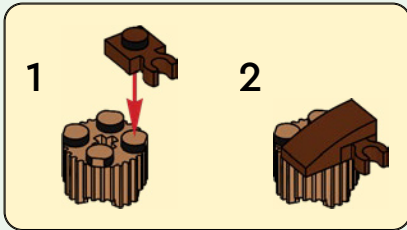

38

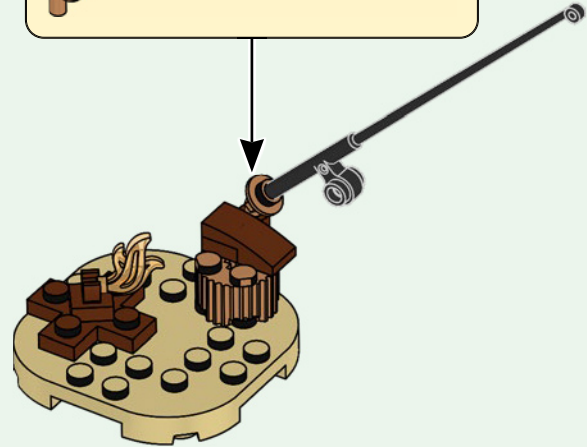
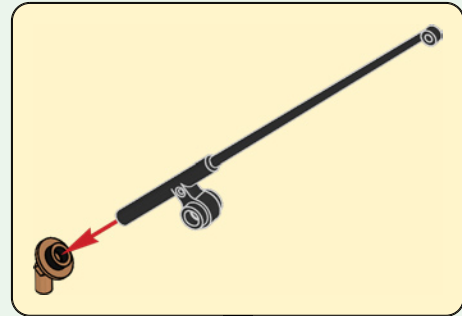



2x

39





2x

40

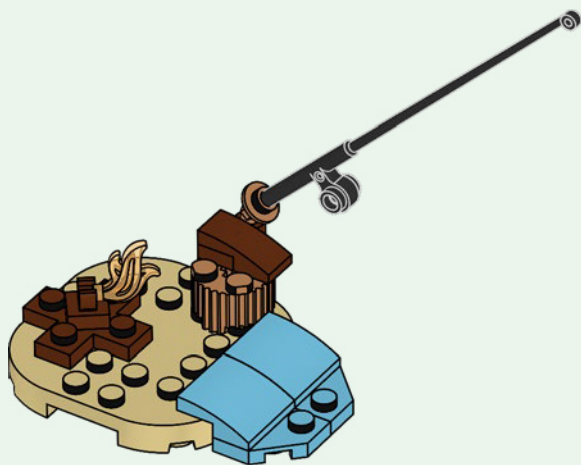

1x



1x



1x

41

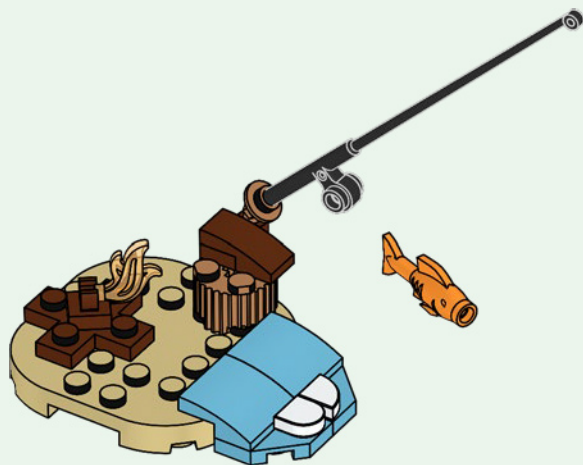

42



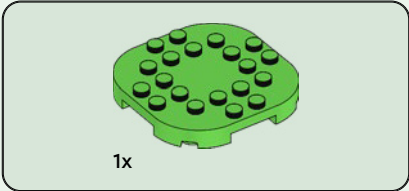

43

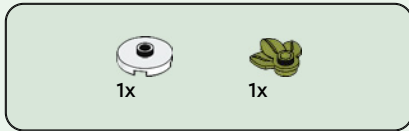
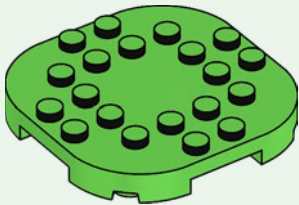

44

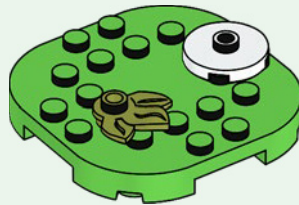



45

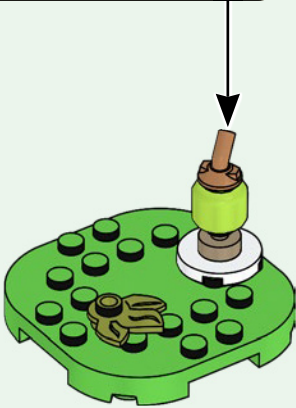
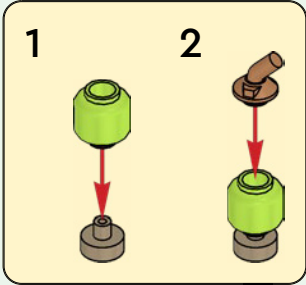





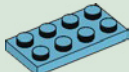

1x

47

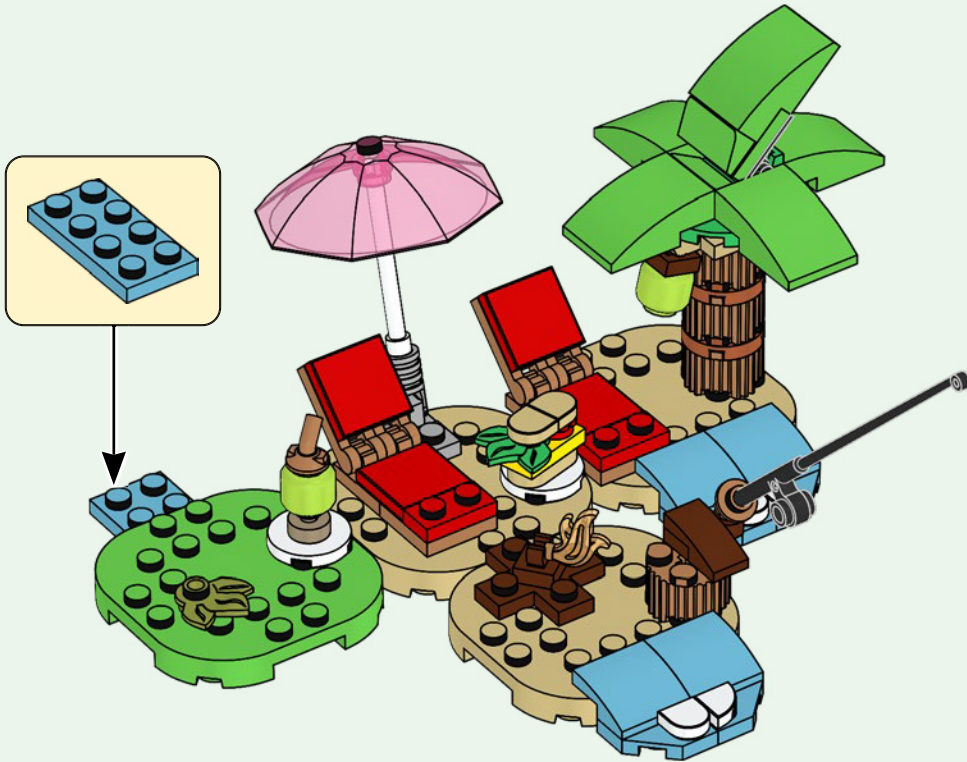

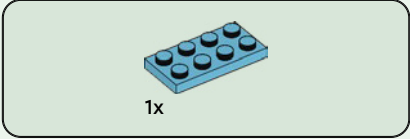
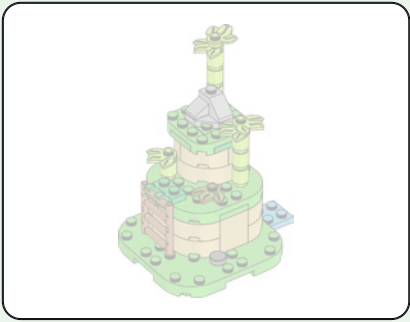

48

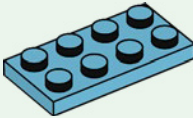

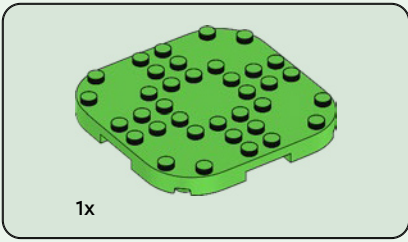

49

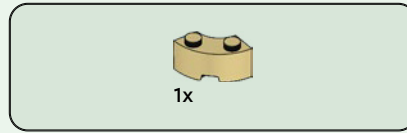
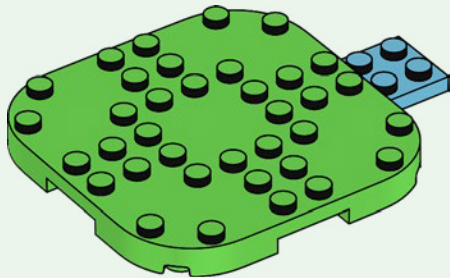

50

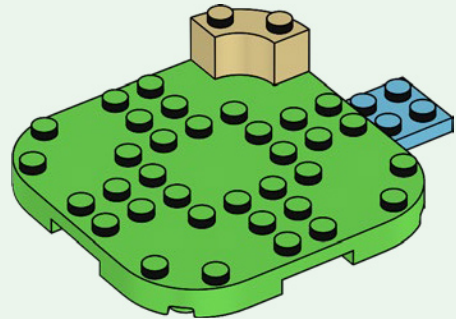



2x

51

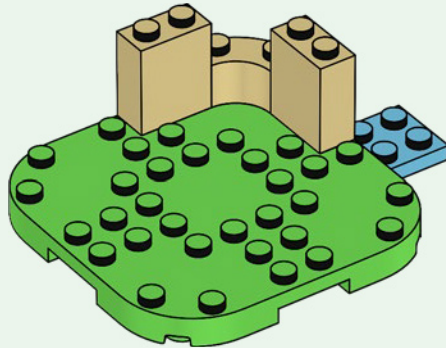

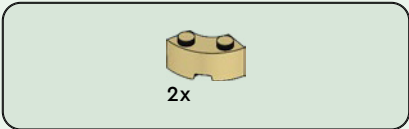

52

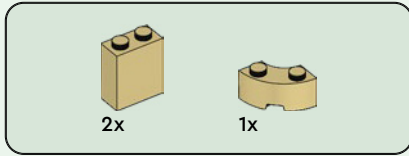
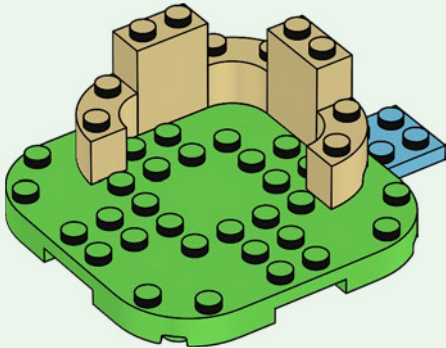

53

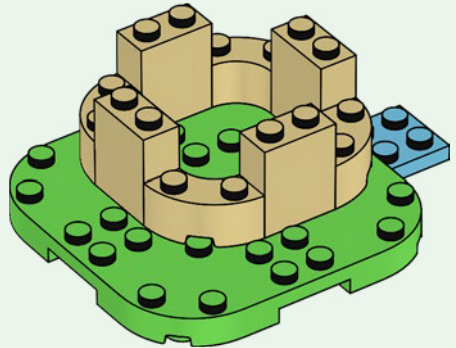



4x

54

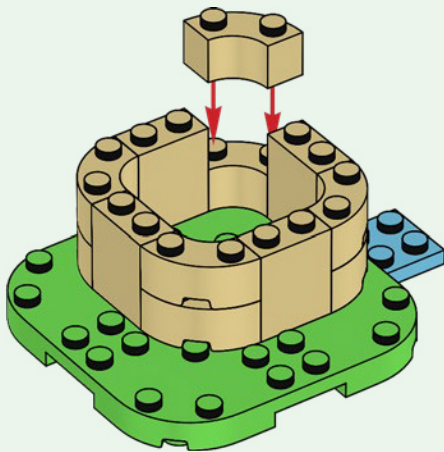

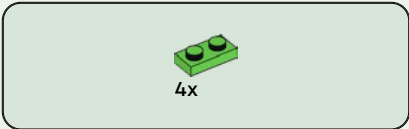

55

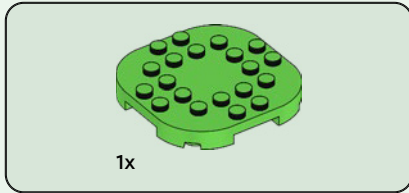
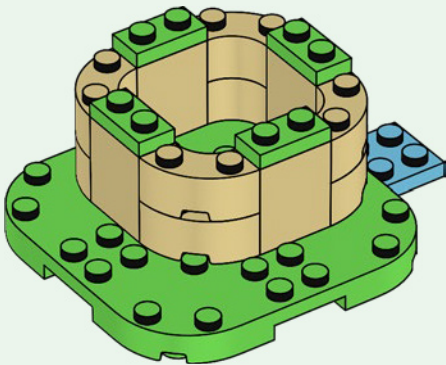

56

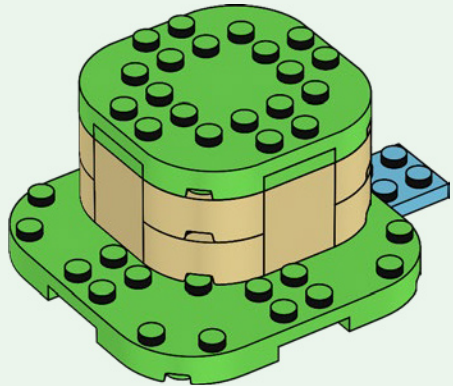

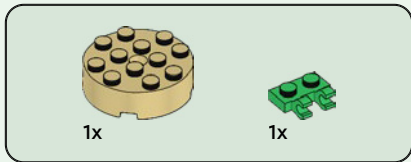

57

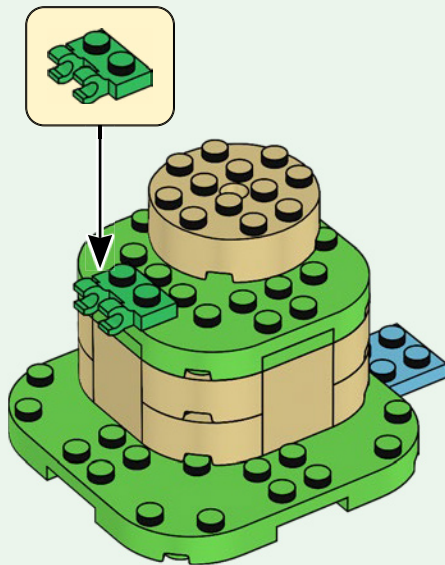

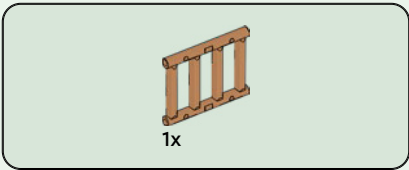

58

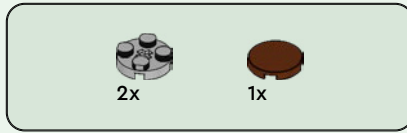
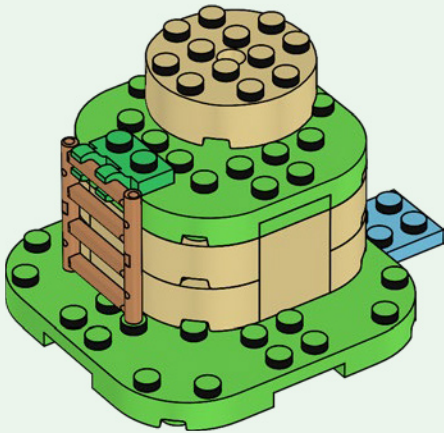

59

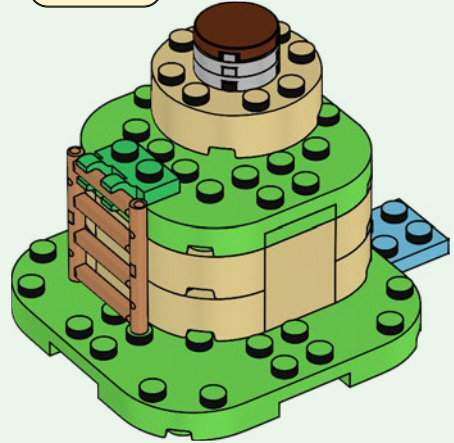
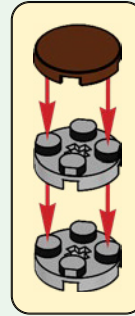



4x

60

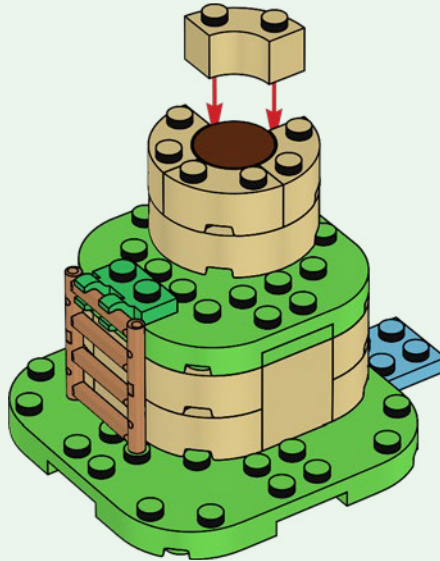

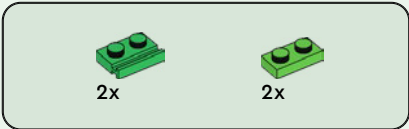

61

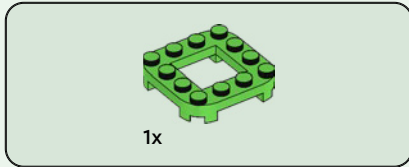
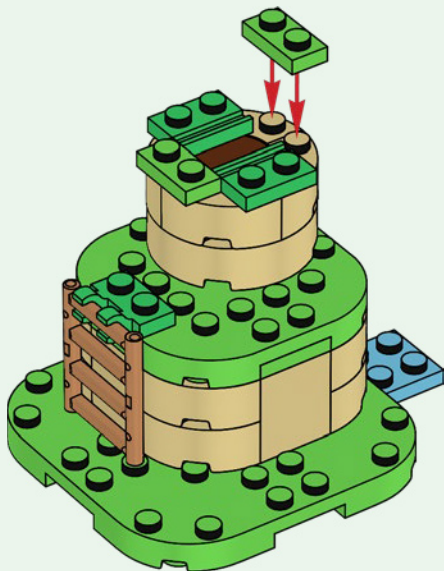

62

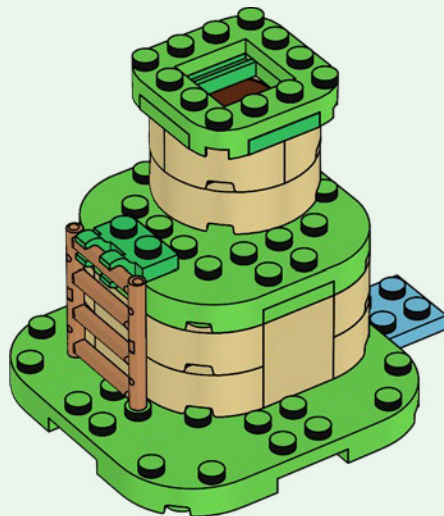

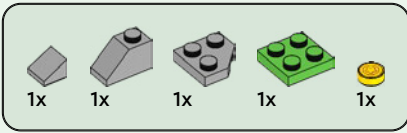

63

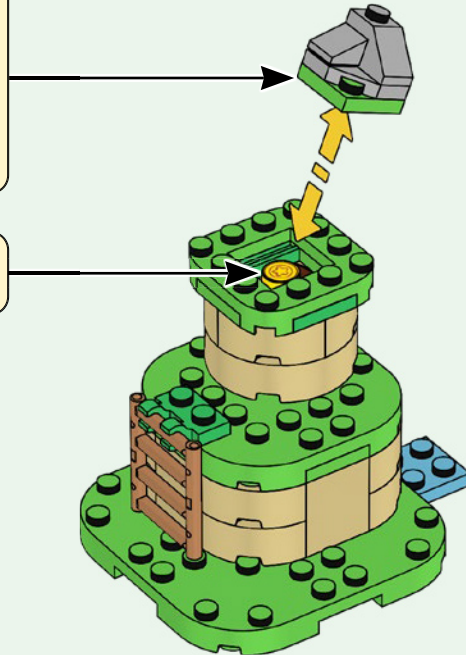
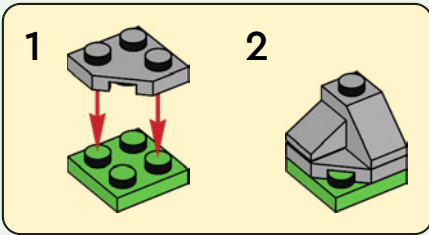



6x



4x

64

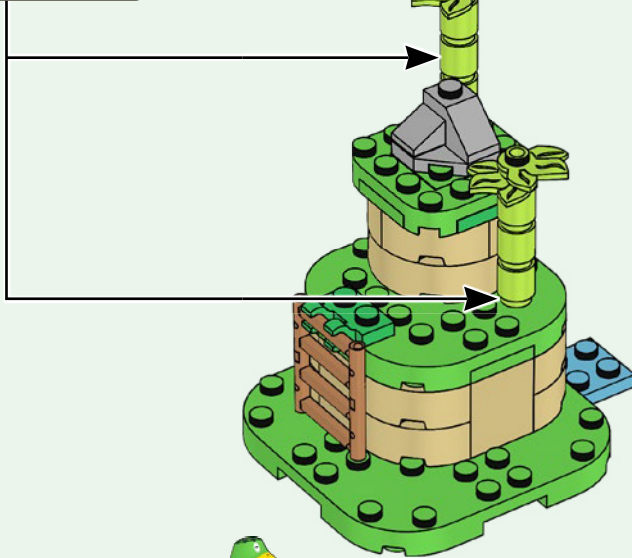
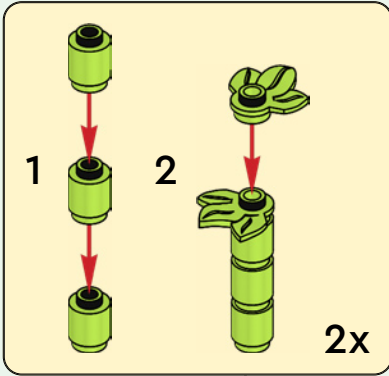



1x



1x



1x



1x

65

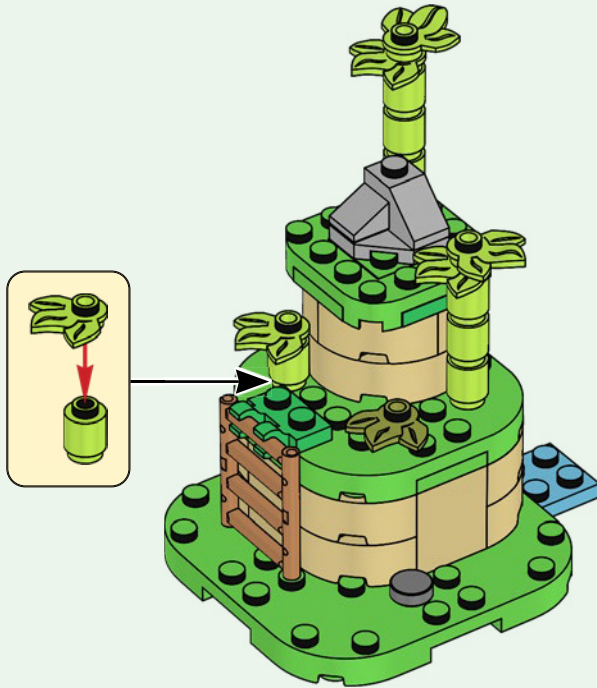



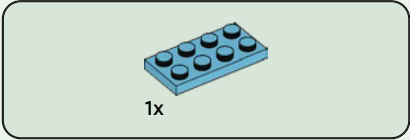
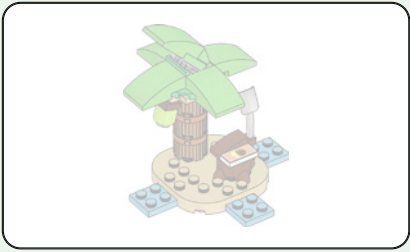

67

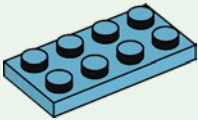

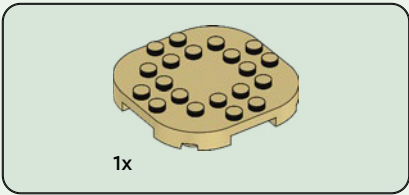

68

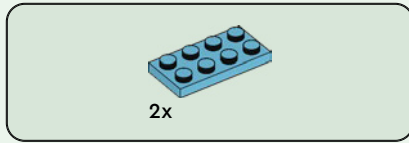
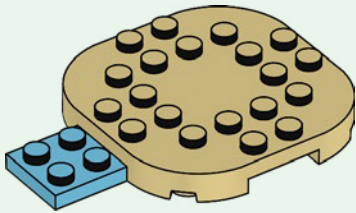

69

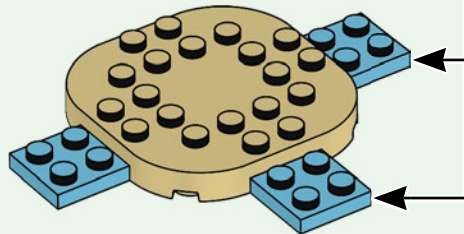
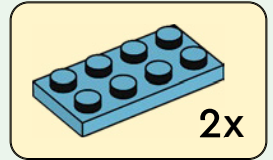

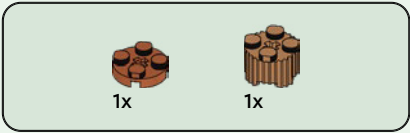

73





74

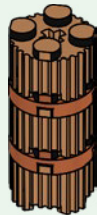

75

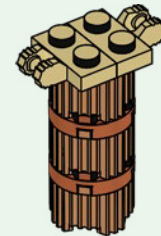



1x

76





77

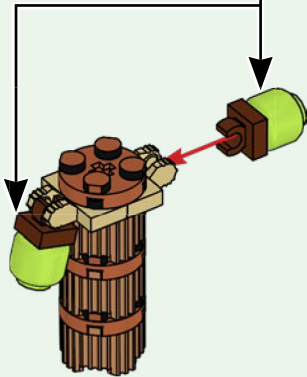
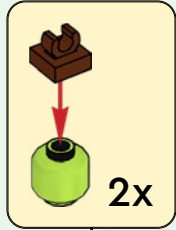

78

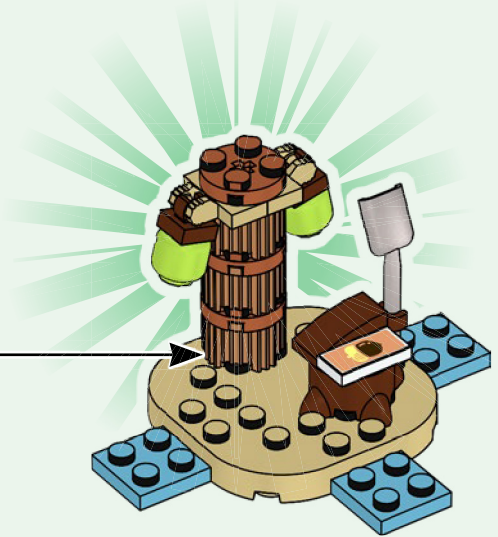

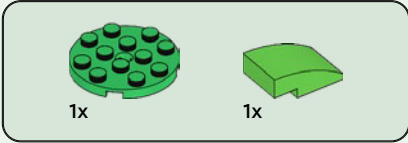
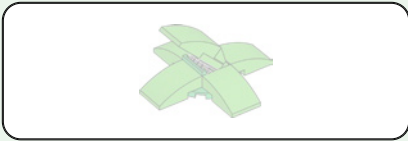

79

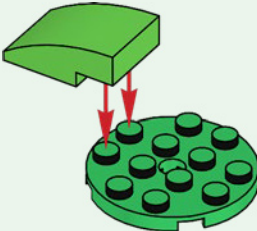



1x



1x

80

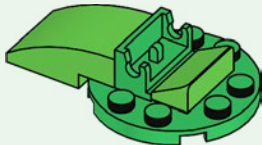

1x

81

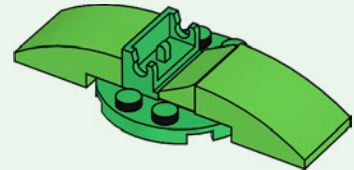



2x

82

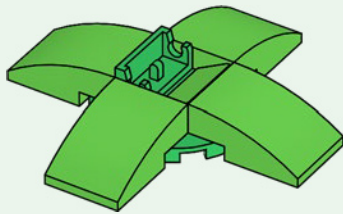



83

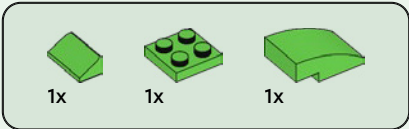
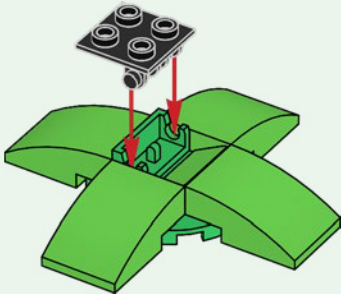

84

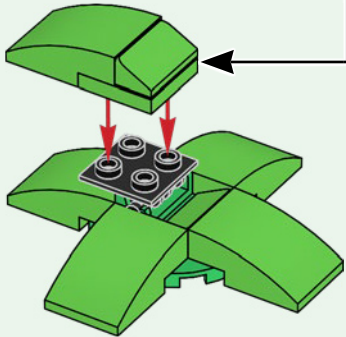
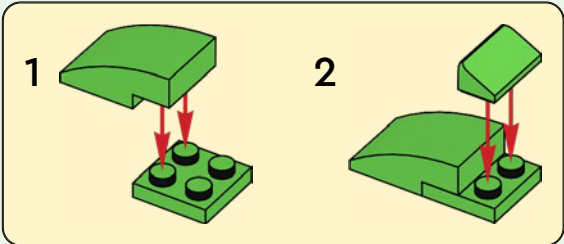

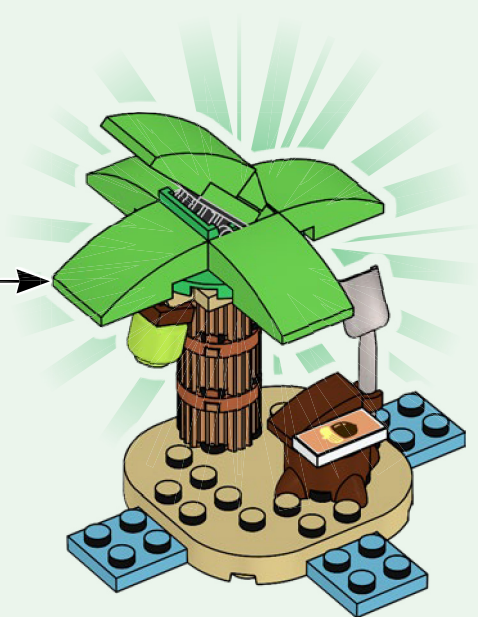



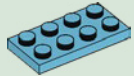
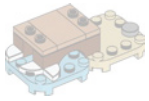

1x

87

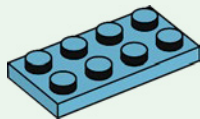

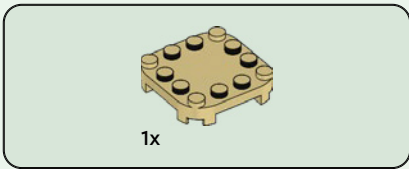

88

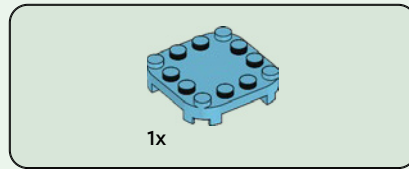
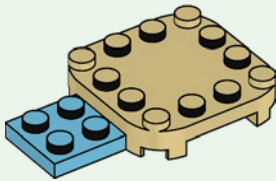

89

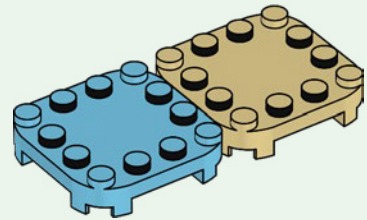

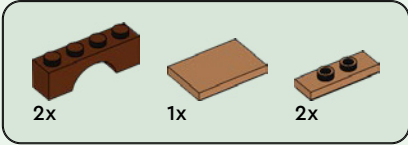
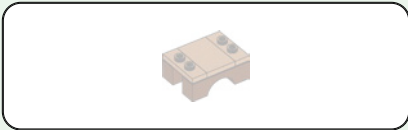

90

1



2



3

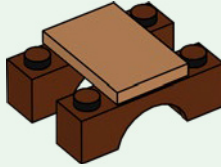

4

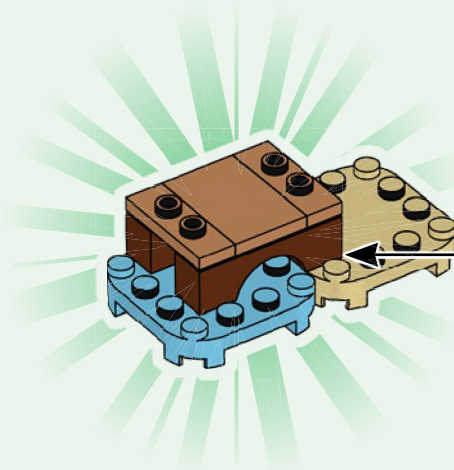
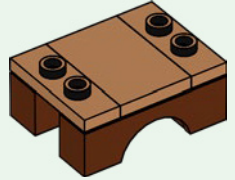



3x



1x

91

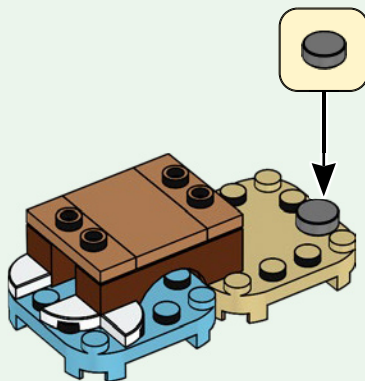

92



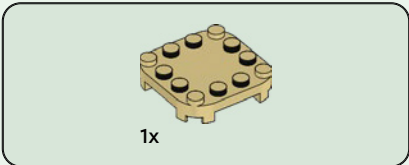

93

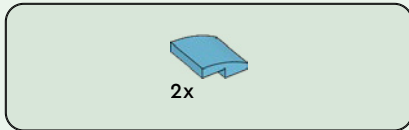
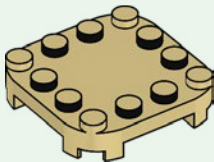

94

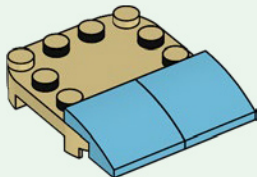



2x

95

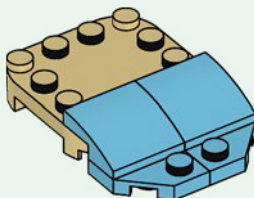



1x



1x

96

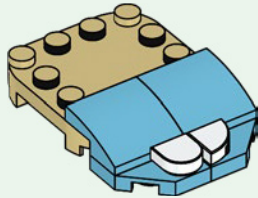

1x



1x



1x

97

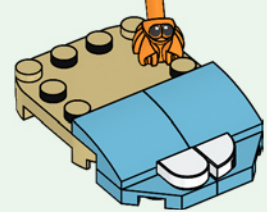
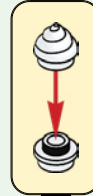





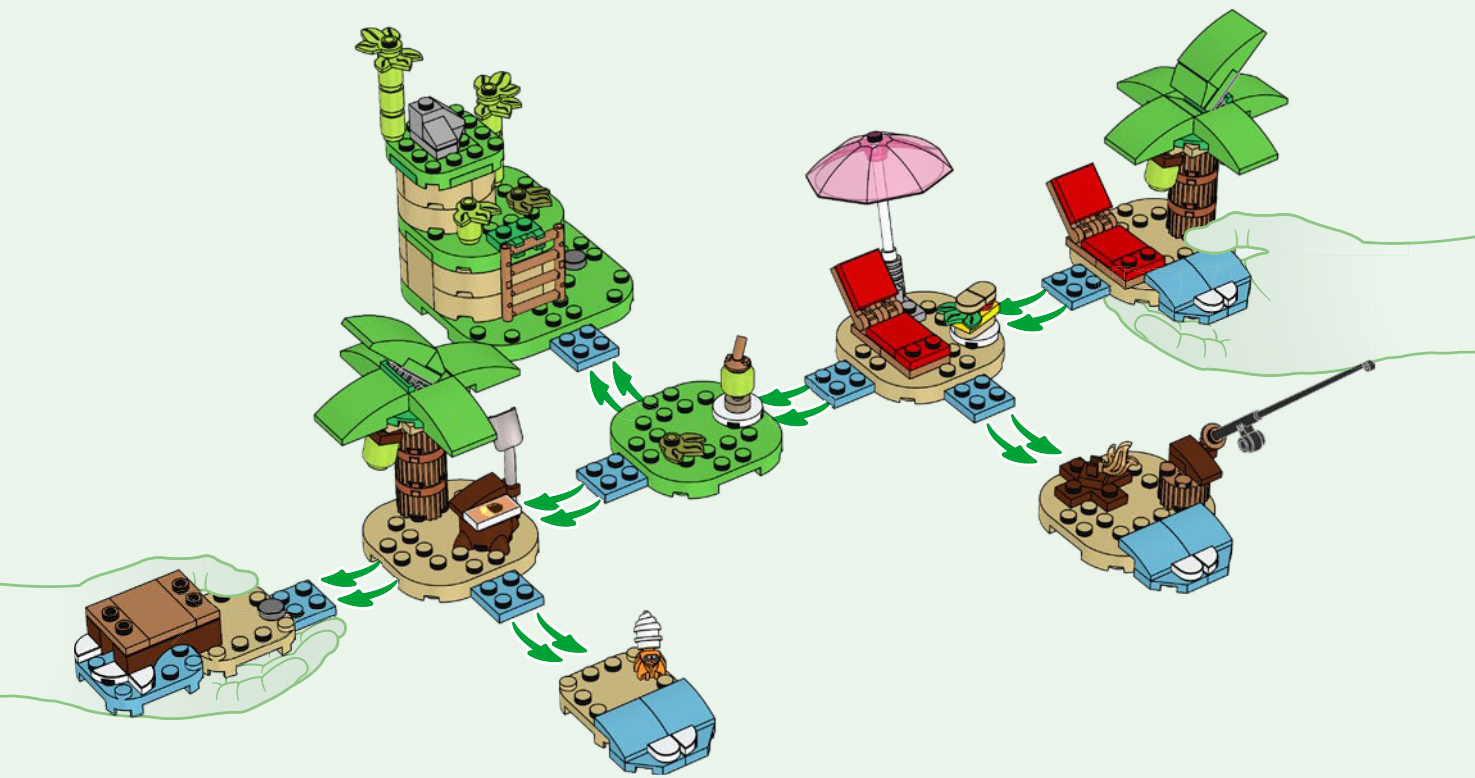

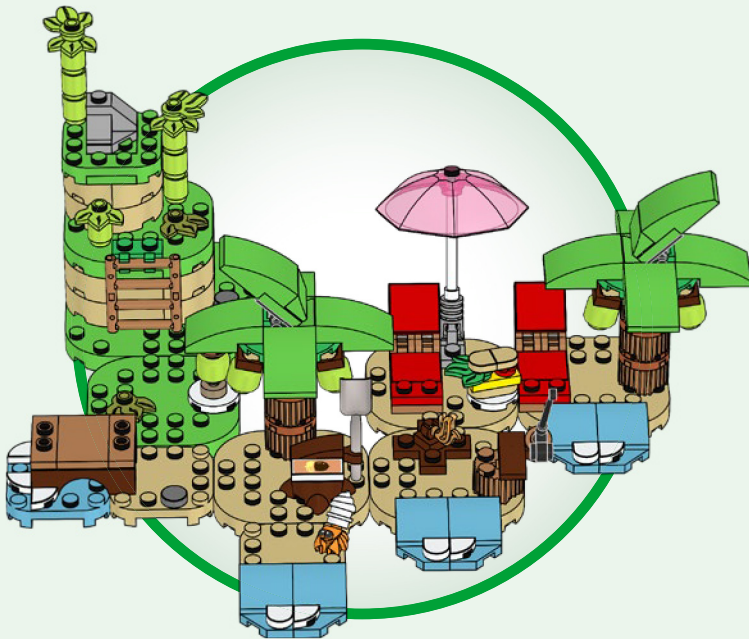
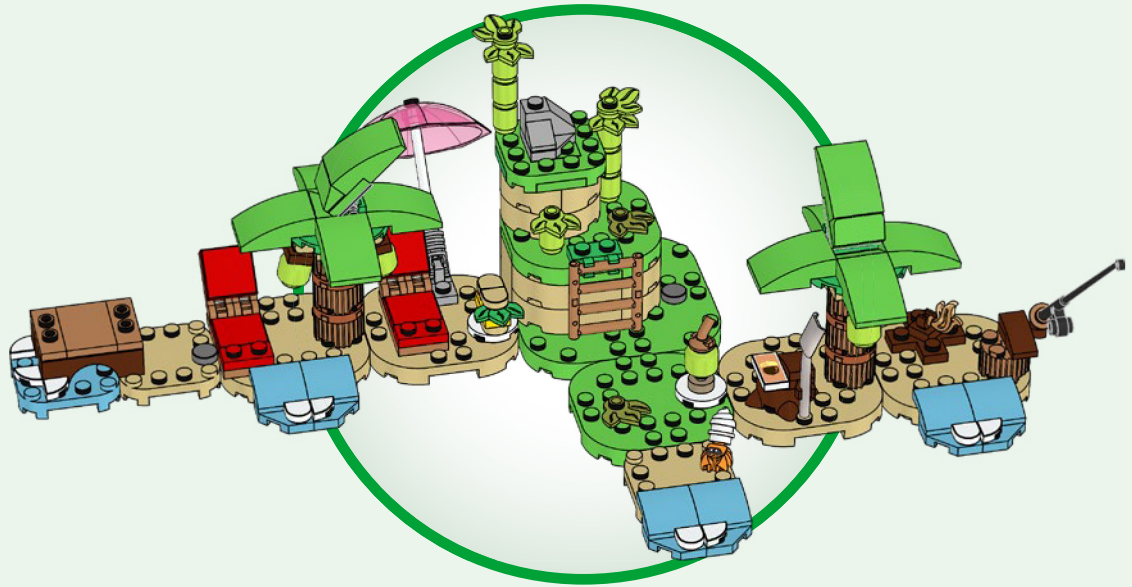



どうぶつの森





77046



77047



77048



77049



77050



1x
6168642



1x
6438901



3x
6250591



6x
6172366



1x
6437184



2x
6093053



1x
6469573



1x
6469549



1x
6469549



1x
302001



2x
6170419

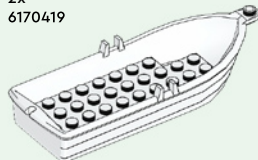

1x
6408680



2x
6353196



1x
6212758



1x
4507055



94



4x
6092587



4x
4159279



4x
6338180



1x
6469550



1x
6468834



1x
4185177



12x
6055868



1x
6294592



1x
6122047



2x
6477326



4x
6301627



2x
614121



1x
6284574



1x
6284574



1x
6284574



1x
6284574



1x
6284574



1x
6284574



1x
6284574



1x
6206148



2x
302321



1x
6365503



1x
368021



4x
306821



1x
6469535



1x
6265497



1x
302324



1x
6270122



2x
4124096



1x
6261348



1x
6313116



1x
6313116



1x
6313116



1x
6313116



1x
6313116



1x
6313116



1x
6313116



1x
6313116



1x
6495143



1x
302123



1x
6229130



2x
6170765



1x
6347288



2x
4272665



2x
6353423



4x
6138510



6x
6343326



1x
6469551



3x
6357612



10x
6462433



1x
6399789



1x
6399789



1x
6399789



1x
6399789



1x
6399789



1x
6399789



1x
6399789

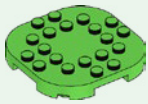

2x
6301631

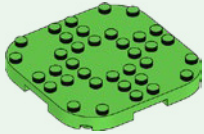

1x
6301641



6x
4616027



1x
6484841



1x
6238674



1x
6486334



1x
6475432



1x
4623481



1x
6276071



7x
4212454



5x
6454724



5x
6286831



1x
6314353



5x
6348057



2x
6337003



1x
6075213



2x
6069984



1x
6468829



1x
6050918



2x
6177697



1x
6258831



1x
4521921



1x
4540203



2x
4211475



1x
6271539



1x
6186657



1x
4211614



1x
6265694



1x
6354568



1x
6102357



1x
4515369



2x
6400315



7x
6481373



4x
6347304



2x
6056383



4x
6167699



2x
6292145



1x
6484621



1x
4211090



3x
6284596



1x
6300320



2x
6231386



1x
6486299



1x
6167599



1x
6187006



2x
6398008



1x
6210601



1x
6229071



1x
6056381



1x
6057387



6x
6249415



6x
6119126



9x
4655256



1x
6469904



 [LEGO.com/service](https://www.LEGO.com/service)

YOU COULD **WIN**



Scan this QR code or go to **LEGO.COM/PRODUCTFEEDBACK** and give us your short feedback about this LEGO® set for a chance to win a cool LEGO prize.

Terms and Conditions apply*

EN: YOU COULD WIN. Terms and Conditions apply* **DE: Du könntest GEWINNEN.** Es gelten die Teilnahmebedingungen* **FR: Tu pourrais GAGNER.** Des conditions s'appliquent* **IT: Potresti VINCERE tu.** Termini e condizioni sono applicabili* **ES: Puedes GANAR.** Aplican términos y condiciones* **PT: Poderá GANHAR.** Aplicam-se termos e condições* **ZH: 轻松获奖. 条款和条件适用*** **PL: Szansa na WYGRANĄ.** Obowiązują warunki korzystania* **CS: Máte šanci VYHRÁT.** Platí všeobecné smluvní podmínky* **SK: Máte šancu VYHRAŤ.** Platia všeobecné zmluvné podmienky* **HU: TE IS NYERHETSZ.** Felhasználási feltételek érvényesek* **RO: Ai putea CÂȘTIGA.** Se aplică termeni și condiții* **BG: Можете да СПЕЧЕЛИТЕ.** Има определени правила и условия* **LV: Tu vari LAIMĒT.** Ir spēkā noteikumi un nosacījumi.* **ET: Sul on võimalus VÕITA.** Kehtivad tingimused* **LT: Jūs galite LAIMĖTI.** Taikomos sąlygos*

*[LEGO.com/productfeedback-terms](https://www.lego.com/productfeedback-terms)